

KÜGELLAGER

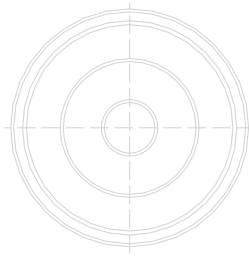

KÜGELLAGER

CATÁLOGO

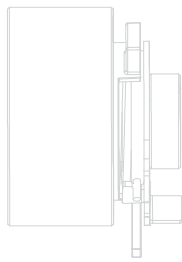
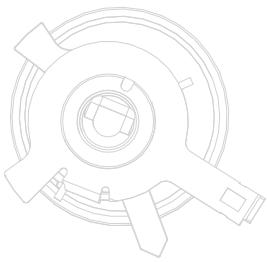

**La reproducción total o parcial de este catálogo
esta prohibida salvo autorización**

La Empresa



KÜGELL S.A., firma continuadora de *Fernando Cavallero e hijo S.R.L.*, es una empresa que cuenta con más de 50 años de trayectoria en la República Argentina, dedicada a la fabricación de autopartes, centrando sus esfuerzos en el desarrollo de tensores de correas, ejes de bomba de agua y rodamientos especiales.

Nuestro principal objetivo es lograr la entera satisfacción de los requisitos del Cliente. Con este fin, en abril de 2001 certificó sus procesos bajo normas **ISO 9001**, asegurando que nuestros productos mantengan siempre óptimos resultados. Así, cuando usted adquiere una pieza **Kügellager**, usted adquiere la mejor calidad.

Para ello, todas las áreas y departamentos de nuestra empresa debieron cumplir con las exigencias pautadas para luego ser auditadas por TÜV Rheinland, el organismo certificador alemán con 130 años en el mundo y más de 30.000 certificados emitidos entre los que se encuentran las firmas de mayor trayectoria global.

El interés por permanecer siempre a la vanguardia se puede apreciar en nuestra Política de la Calidad.

ENTREGAR AL MERCADO PRODUCTOS DE CALIDAD SUPERIOR QUE SATISFAGAN LAS NECESIDADES DE NUESTROS CLIENTES MÁS ALLÁ DE SUS EXPECTATIVAS.

Nuestra Política de la Calidad está basada en los siguientes objetivos:

· Desarrollar un Sistema de la Calidad basado en la satisfacción de las actuales necesidades de los mercados, garantizando la calidad de nuestros productos.

· Difundir nuestra política entre todos los que componemos la Empresa incluyendo clientes y proveedores, para que la calidad sea un estilo de vida, proporcionando así una atmósfera que nos motive a superarnos día a día.

· En Kügell S.A., nos comprometemos a desarrollar un sistema de continuo mejoramiento de nuestros productos y procesos.

La planta se encuentra en la ciudad de Córdoba, donde se realizan permanentes desarrollos tendiendo a cubrir todas sus necesidades.

La distribución de los productos abarca a todo el territorio de la República Argentina, a través de mayoristas con gran cobertura. Está dentro de los objetivos el atender a nuevos mercados, tanto del MERCOSUR como del resto del mundo.



The Company

KÜGELLS.A., continuing company of *Fernando Cavallero e hijo S.R.L.*, is a car parts company with more than 50 years of path in the Republic Argentina, developing Belt tensors. Our principal goal is achieving our customers' requirements satisfaction. On April 2001 certified the processes under International norms of Quality Management Systems **ISO 9001** making sure to have the most favourable results. When you buy a **Küeggellager** piece, you get the best quality.

For this reason, all the departments of our company had to accomplish with established requirements to be later audited by **TÜV Rheinland**, the German certifier organization with 130 years the World and more than 30.000 certificates issued among those with global trajectory.

Our interest to be always at the forefront can be appreciated in our Quality Policy:

DELIVER TO THE MARKET HIGH QUALITY PRODUCTS THAT SATISFY OUR CUSTOMERS' NEEDS BEYOND THEIR EXPECTATIONS.

Our Quality Policy is based on the following goals:

·Develop a Quality System based on the satisfaction of markets' present needs, living Guaranty of Quality to our products.

·Spread our policy among all the members of this company including customer and suppliers. We want Quality to be a life-style, living in this way and atmosphere tos to grow day by day.

·In Küeggell S.A. we have a commitment: Developing a System of continuous improvement in our products and processes.

The plant is located in the city of Córdoba where permanent developments are done to cover all the needs. Products are distributed all around the country through wholesalers. Our objective is to serve new markets such as MERCOSUR and the rest of the World.





Tensores integrales

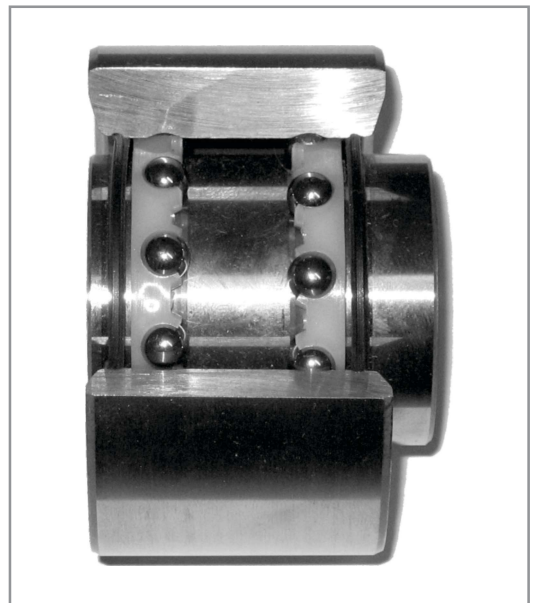
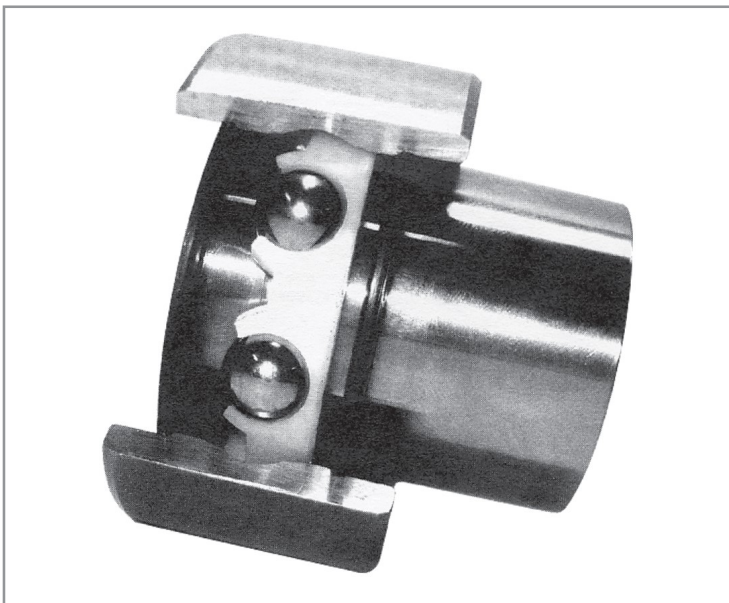

Características:

- *Diseño como los originales*
- *Pistas talladas, diámetro mayor.*
- *Grasa de alta temperatura*
- *Separador de Nylon autolubricado, más silencioso*
- *Mayor capacidad de carga, tanto dinámica como estática.*





Algunas recomendaciones para el correcto montaje de Poleas Tensoras

- 1- Asegúrese de que el que está reponiendo corresponde exactamente al modelo de motor.
- 2- Una vez montados, antes de colocar la correa, vea que giren libremente (no invertir la posición del tensor fijo por el móvil).
- 3- Coloque la correa y aplique la tensión INDICADA POR EL FABRICANTE DEL MOTOR, cuidando que quede alineado todo el conjunto (engranajes, tensores, correa, etc.)
- 4- Coloque la tapa (si es de la distribución) y vea que ajuste correctamente, ya que puede frenar los tensores.
- 5- Evite el lavado del motor con vapor, ya que la gran presión del agua puede introducirse en rulemanes y tensores (el agua es el enemigo número uno de los rodamientos). No se reconocerán reclamos cuando se detecte óxido, especialmente en el interior de los mismos.
- 6- Si al poner en marcha el motor luego del armado escucha ruidos anormales, detenga inmediatamente el mismo y verifique el correcto montaje.
- 7- Es indispensable disponer para el montaje de herramientas adecuadas y aparatos de medición de la tensión de correa. UNA ELEVADA TENSIÓN OCASIONA LA RÁPIDA DESTRUCCION DE LOS TENSORES.

Some recommendations for the correct Assembly of Belt tensioner pulleys

- 1- Make sure that Belt tensioner pulley you are replacing goes with the model of the Enghien.
- 2- Check that the belt tensioner pulleys move freely before assembling the Belt (do not invert the fixed pulley and the movable one).
- 3- Put the Belt and tighten according to the Enghien manufacturer; the gears; the Belt tensioner pulleys; Belt; etc, must be lined up.
- 4- Put the distributor cap and adjust it properly since it can stop the Belt tensioner pulley from working.
- 5- Avoid washing the Enghien with steam since the pressure of water may enter ball bearing and Belt tensioner pulley (water is Number one enemy of all bearings). Claims will not be accepted if oxide is detected especially in the interior of the pieces.
- 6- If alter the assembly you hear abnormal rounds, stop the Enghien immediately check again the proper mounting.
- 7- It is Essential to have the proper Tools and tension pulley measuring devices for the mounting. High tension causes quick destruction of the tensioner pulley.

Reemplace los tensores con cada cambio de correa, aunque parezcan en buen estado (el calor y el tiempo transcurrido destruyen el lubricante).

Cualquier defecto en el conjunto de distribución puede ocasionar graves averías al motor.

Replace the Belt tensioner pulleys every time you change the Belt even if they look all right. Remember that heat and time damage the lubricant.

Any defect in distribution can cause serious damage in the engine.

LIMITACIÓN DE RESPONSABILIDAD:

KÜGELLAGER no se responsabiliza de los daños emergentes ocasionados por un mal montaje de sus productos, o si cualquiera de las piezas no es utilizada en forma correcta. Recomendamos atenerse estrictamente a las instrucciones brindadas por los fabricantes del motor para su seguro y correcto funcionamiento, especialmente las referidas a la tensión de las correas, debiendo disponerse además, de las herramientas adecuadas, tanto para su instalación como para la medición. Las imágenes de los productos son de carácter ilustrativo, pueden variar sin previo aviso.

Nota aclaratoria: Las marcas de automóviles y datos contenidos en el presente catálogo son al solo efecto de permitir una mejor definición de los repuestos a reemplazar. Ante dudas consulte siempre con el fabricante del motor. No se aceptaran reclamaciones por posibles errores contenidos en este catálogo. Nos reservamos el derecho de modificación del presente catálogo sin aviso previo.



ÍNDICE

POLEA DE GIRO LIBRE DE ALTERNADOR	11
TENSOR PARA CORREA: LINEA ALFA ROMEO	15
TENSOR PARA CORREA: AUDI - SEAT	17
TENSOR PARA CORREA: LINEA CHEVROLET	20
TENSOR PARA CORREA: LINEA <i>CITROËN</i>	24
TENSOR PARA CORREA: LINEA DAEWOO	31
TENSOR PARA CORREA: LINEA FIAT	32
TENSOR PARA CORREA: LINEA FORD	38
TENSOR PARA CORREA: LINEA JEEP - ISUZU	44
TENSOR PARA CORREA: LINEA MERCEDES BENZ - ROVER	45
TENSOR PARA CORREA: LINEA PEUGEOT	47
TENSOR PARA CORREA: LINEA RENAULT	55
TENSOR PARA CORREA: LINEA SUZUKI	61
TENSOR PARA CORREA: LINEA TOYOTA - DODGE	62
TENSOR PARA CORREA: LINEA VOLKSWAGEN	63
TENSOR PARA CORREA: LINEA VOLVO	68
TENSOR PARA CORREA: LINEA KIA - HYUNDAI	69
TENSOR PARA CORREA: LINEA IVECO - SCANIA	70
RODAMIENTOS ESPECIALES	71
RULEMÁN DE VENTILADOR	72
RODAMIENTOS AGRÍCOLA	73
EJES DE BOMBA DE AGUA	74
KIT DE DISTRIBUCIÓN	75



Medidas de referencia de cada tipo de polea tensora

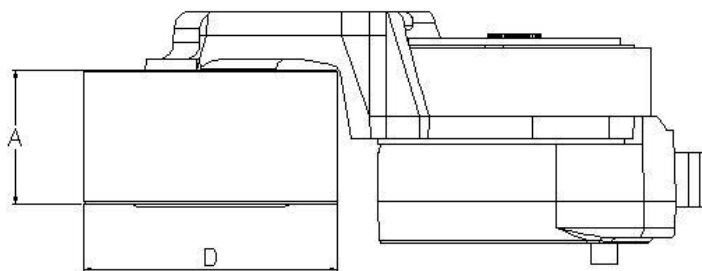
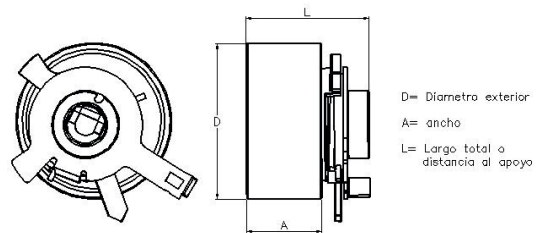
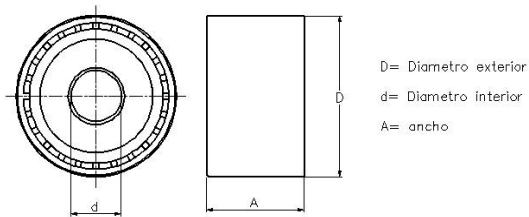
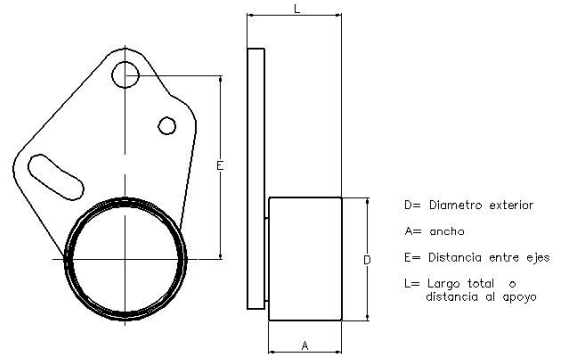
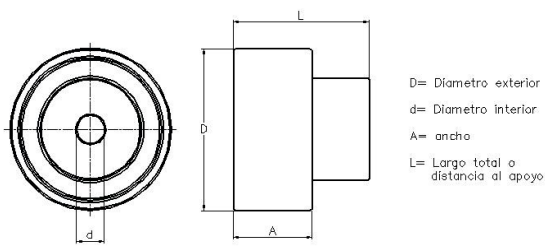

D= Diámetro exterior
A= ancho
E= Distancia entre ejes

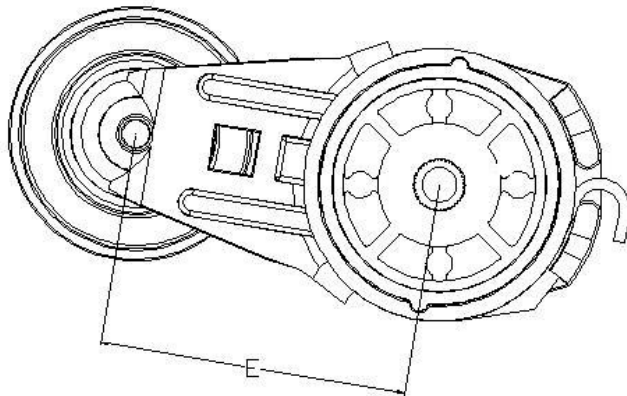

Nota aclaratoria: Se presentan diferentes tipos de poleas tensoras con las medidas que se tienen en cuenta en el presente catálogo.

**ENTERATE DE
NUESTRAS
PROMOCIONES Y
NOVEDADES EN
NUESTRO
CATÁLOGO WEB**



ESCANEÁ EL CÓDIGO QR



DISPONIBLE EN:





CATÁLOGO 2021 - 2022



RECOMENDACIONES GENERALES PARA POLEA DE GIRO LIBRE

En estado montado es difícil evaluar el funcionamiento de una polea de giro libre de alternador. Por consiguiente, se recomienda comprobar su funcionamiento antes de montarla.

Los pasos para realizar la comprobación son los siguientes:

1. Sujetar el aro interior y fijarlo.
2. Girar el aro exterior en el sentido de accionamiento del alternador. Si el funcionamiento es correcto, no será posible girar el aro exterior.
3. Girar el aro exterior en sentido contrario al funcionamiento del alternador, sujetando el aro interior. Si el funcionamiento es correcto, el aro exterior se podrá girar con una ligera resistencia.

IMPORTANTE:

- Una vez montado verificar el funcionamiento solamente con la caperuza protectora colocada.
- Si una de las dos funciones no es correcta, la polea de giro libre se debe cambiar obligatoriamente.
- Recomendamos atenerse estrictamente a las instrucciones brindadas por los fabricantes del motor para su seguro y correcto funcionamiento.

ALGUNOS MOTIVOS PARA REALIZAR EL CAMBIO DE LA POLEA DE GIRO LIBRE:

Puntas del perfil fuertemente desgastadas, causas de este defecto:

- Tensión en la transmisión insuficiente, como consecuencia, la correa se desliza por la polea de giro libre.
- El funcionamiento de la polea de giro libre de generador no es correcto.

Bordes de guía desgastados, causas de este defecto:

- Error de alineación entre los rodillos de los grupos (error de montaje).
- Correa colocada incorrectamente.

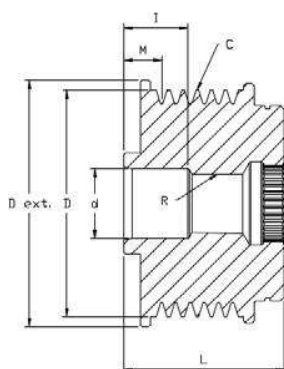

MEDIDAS A TENER EN CUENTA

- D ext.= diámetro exterior
- d = diámetro de entrada
- L = largo total
- I = longitud de la sección de unión
- M = medida al primer canal
- C = números de canales
- R = tamaño y tipo de rosca









Cod. / Tipo de medida en mm	D ext.	D	d2	L	I	M	C	R
1900	61	56	17	33,7	11	3,45	6	M16x1,5
1901	61	56	17	39,5	16	9,3	6	M16x1,5
1902	59	56	17	42,5	14	17	6	M16x1,5
1904	55	50	17	40	16	14,6	6	M16x1,5
1905	61	56	17	41	16	10,8	6	M16x1,5
1906	55	55	17	38,5	11	7	6	M16x1,5
1907	65	58	17	38,7	11	8	7	M16x1,5
1908	65	58	15	41,5	12,5	10,8	7	M14x1,5
1909	59	54	17	38,8	14,5	12,8	6	M16x1,5
1910	61	56	17	41,5	11	14,8	6	M16x1,5
1911	61	55	17	35,5	12	5	6	M16x1,5
1912	77	55	17	41,3	15,7	17,5	6	M16x1,5
1913	55	49,5	17	40,5	11	14,5	6	M16x1,5
1914	59	54	17	35	11,3	8	6	M16x1,5
1915	61	56	17	35	16	4,75	5	M16x1,5
1916	53,3	48,6	17	40,8	16	11,6	7	M16x1,5

Artículo Article	Modelos que reemplazan Models that they replace	Dimensiones Dimensions	Equivalencias Equivalences
1900	 <p>Volkswagen Gol, Gol Country 1.9D Saveiro 1.9SD (377 903 015)</p>	<p>Ø56 x 6 ranuras L=33,7</p>	<p>INA 535003210 F-230209.03 VKM 01007</p>
1901	 <p>Chevrolet Blazer 2.8 TD / S10 2.8 TD (93297735) Mercedes Benz Sprinter 2.8 TD Nissan Frontier 2.8 TD motor MWM 4 cilindros</p>	<p>Ø56 x 6 ranuras L=39,5</p>	<p>INA 535006010 F-233593 VKM 03111</p>
1902	 <p>Renault Clio / Megane / Scenic II / Kangoo todos 1.9 DCI y DTI (77 01 055 871)</p>	<p>Ø56 x 6 ranuras L=42,5</p>	<p>INA 535010510 F-550181</p>
1904	 <p>VW Polo - Caddy - Vento 1.9 Seat Cordoba 1.9 SD Polea de marcha libre</p>	<p>Ø50 x 6 ranuras L=40</p>	<p>VKM 03106 INA 535000110 F-225355</p>
1905	 <p>RENAULT CLIO, MEGANE, SCENIC II MOTOR 1.9 DCI F9Q 732-733</p>	<p>Ø56 x 6 ranuras L=41</p>	<p>VKM 03600 INA 535002810 F-228881.3</p>
1906	 <p>CITROEN BERLINGO, C5, EVASION, XANTIA, XSARA 2.0 HDI / PEUGEOT206, 306, 307, 406, EXPERT 2.0 HDI</p>	<p>Ø55 x 6 ranuras L=38,5</p>	<p>INA 535003910 VKM 03301 VKM 03003 F-229606</p>
1907	 <p>TOYOTA HILUX 2.5 D. - 4D y 3.0 D -4D FORD RANGER 2.2 y 3.2 TDCI, TRANSIT 2.4 TDCi y 3.2 TDCi LAND ROVER DEFENDER 110, 130, 90 2.4 TDCI 4WD</p>	<p>Ø58 x 7 ranuras L=38,7</p>	<p>27415-0L040 INA 535012810 F-556174.01 VKM 03412</p>
1908	 <p>TOYOTA HILUX 2.5 D. - 4D Land Cruiser 3.0 D - 4D y TD</p>	<p>Ø58 x 7 ranuras L=41,5</p>	<p>27415-0L010 27415-0L030 27415-30010 27415-30020 VKM 06107 INA 535017310</p>
1909	 <p>CITROËN Berlingo 1.9D, C2 C3 1.4 HDI C4 - C4 Picasso y Xsara Picasso1.6 HDI PEUGEOT 206 207 307 1.4 HDI, 206 207 1.6 HDI, Boxer II Expert II y Partner 2.0 HDI</p>	<p>Ø54 x 6 ranuras L=38,8</p>	<p>INA 535006210 VKM 03305 F-236591.01</p>





Artículo Article	Modelos que reemplazan Models that they replace	Dimensiones Dimensions	Equivalencias Equivalences
1910	AUDI A3 – A4 1.9 TDI SEAT ALHAMBRA – LEON 1.9 TDI ALTHEA 2.0 TDI VOLKSWAGEN BORA – GOLF – MULTIVAN SHARAN – VENTO 1.9 TDI	Ø56 x 6 ranuras L=41,5	F-227628 INA 535001210 VKM 03100
1911	VOLKSWAGEN GOL / GOL COUNTRY 1.9D GLD /SD SAVEIRO 1.9D.	Ø55 x 6 ranuras L=35,5	F-225653.06 INA 535000510 VKM 03107
1912	RENAULT CLIO / EXPRESS / DUSTER / FLUENCE / SYMBOL / SANDERO / LOGAN / SCENIC / MEGANE / KANGOO 1.6 16V - MOTOR K4M	Ø55 x 41,3 6 ranuras	VKM 03612 F-557755 F-550181.03 7701477689
1913	AUDI A3 3.2 / A4 y Q5 2.0 tdi / TT 3.2 SEAT CORDOBA / IBIZA 1.4 y 1.9 tdi VW FOX 1.4 / POLO 1.4 y 1.9 / PASSAT 3.2 y 3.6 / AMAROK 2.0 tdi / GOLF 3.2	Ø50 x 40,5 6 ranuras	F-551406 VKM 03112 Bosch F00M 147876 535012410
1914	CITRÖEN C3, C4, C5 1.6 / C8 2.0 y 2.2 FIAT SCUDO 1.9D / DUCATO 2.0 16v ELYSSE 1.6 - 2.0 JTD PEUGEOT BOXER - EXPERT - PARTNER -206 1.6 y 2.0 / 306 - 307 - 406 2.0 HDI	Ø54 x 35 6 ranuras	VKM 03302 535005910 F-232369.04
1915	VOLKSWAGEN PASSAT 1.9 TDI PASSAT VARIANT 1.9 TDI / AUDI A4 1.9 TDI, A4 AVANT 1.9 TDI, TDI QUATTRO, A6 AVANT 1.9 TDDI, A6 1.9 TDI	Ø56 x 35 5 ranuras	VKM 03102 VKM 01009 535000410 F-225653.11
1916	RENAULT DUSTER 2.0 F4R / MEGANE II 2.0 DCI / LAGUNA 2.0 DCI / ESPACE IV 2.0 / TRAFIC II 2.0 DCI NISSAN Q TRAIL; PRIMASTER DUALIS, QASHQAI 2.0 DCI	Ø54 x 35 6 ranuras	VKM 03302 535005910 F-232369.04

Artículo Article			Modelos que reemplazan Models that they replace	Dimensiones Dimensions	Equivalencias Equivalences
1412		DISTRIBUCION	Tensor Móvil Excéntrico ALFA ROMEO 164 2.0 TURBO	Polea Ø60 x 25 L=50mm	(60800148) INA F-123633 VKM 12005
1413		DISTRIBUCION	Polea Fija ALFA ROMEO 145 1.9D/TD, 155 2.0TD, 146 1.9D/TD	Polea Ø61 x 33 L=57mm	(60811487) INA F-123650 VKM 22153
1414		DISTRIBUCION	Tensor Móvil Excéntrico ALFA ROMEO 145 1.9D/TD, 155 2.0TD, 146 1.9D/TD	Polea Ø61 x 33 L=56.5mm	INA F-123637 VKM 12153
1417		POLY V	Polea Fija de ACCESORIOS ALFA ROMEO 164 2.0 16V, 164 1.9D/TD (Metálica)	Ø80 x 23 x Ø20	532022910 (60805460) F-110627.4 VKM 32009 532019320
1418		POLY V	Polea Fija de ACCESORIOS ALFA ROMEO 164 2.0 16V, 164 1.9D/TD (Nylon)	Ø80 x 23 x Ø20	532022910 (60805460) F-110627.4 VKM 32009 532019320
1424		POLY V	Tensor Fijo ALFA ROMEO 164 1.9D / TD NYLON	Polea Ø79 x 26 L=28 mm	F-110672.30 (60805460) VKM 32005
1425		POLY V	Polea Fija ALFA ROMEO 156 2.5 V6 24v	Ø81 X 26 X Ø17	(60805460) INA F-123758 VKM 32299
1429		POLY V	Tensor Alfa Romeo 145/146 1.4- 1.6-1.7-1.8 16v / 147 1.6 16v, 155 1.7 16v	Polea Ø90 x 25 L=36 mm	(60812515- 60610908- 6061090873501924- 73501924 -7763320) VKM 32001 532036920
1434		DISTRIBUCION	Alfa Romeo 145 / 146 / 147	Ø53 x 29 L=31,5 mm	532028710 VKM 22179 F-231511.07









Artículo Article	Modelos que reemplazan Models that they replace	Dimensiones Dimensions	Equivalencias Equivalences
<p>1434P</p>  <p style="writing-mode: vertical-rl; transform: rotate(180deg);">DISTRIBUCION</p>	<p>Alfa Romeo 145 / 146 / 147</p> <p>Polea Sola</p>	<p>Ø53 x Ø17 x 29 L=31.5 mm</p>	<p>532061110 VKM 22180</p>
<p>1436</p>  <p style="writing-mode: vertical-rl; transform: rotate(180deg);">POLY V</p>	<p>Autotensor Alfa Romeo Giulietta 1.4 Turbo</p>	<p>Ø65 x 23 L= 35</p>	<p>VKM 32023 534006910 F-236663</p>
<p>1436P</p>  <p style="writing-mode: vertical-rl; transform: rotate(180deg);">POLY V</p>	<p>Polea recambio Autotensor Alfa Romeo Giulietta 1.4 Turbo</p>	<p>Ø65 x 23</p>	<p>Polea Recambio VKM 32023 534006910 F-236663</p>
<p>1437</p>  <p style="writing-mode: vertical-rl; transform: rotate(180deg);">DISTRIBUCION</p>	<p>Alfa Romeo 145 / 146 / 147 / 159 1.9 16v / 156 2.4 Jtd</p>	<p>Ø65 x 30 L=41</p>	<p>VKM 12174 1987949804 947478 T-43211 / T-43042 F-232477 531025530 531084410</p>

Artículo Article		Modelos que reemplazan Models that they replace	Dimensiones Dimensions	Equivalencias Equivalences	
1452		DISTRIBUCION	Tensor Móvil AUDI 80, 100, COUPE SEAT CORDOBA, IBIZA, TOLEDO, INCA MOTOR AUDI AFT 1.6-1.8-2.0	Polea Ø72 x 24 L=28.5 mm	(056109243 D) INA F-217668 VKM 11000 F-220093
1537P		POLY V	Seat Altea, León 2.0 TdI Audi A3 2.0 140 CV TDI Audi A4 2.0 143 CV TDI Audi Q5 2.0 170 CV TDI	Ø70 x 25	Polea recambio 534016410 T38427 VKM 310580
1591		POLY V	Polea de ACCESORIOS (FIJA) SEAT CORDOBA, IBIZA, TOLEDO, ALHAMBRA, INCA MOTOR 1.6 (1F), 1.8 1.9D/SDI/TDI, 2.0, 2.0 16V NYLON	Ø78 x 26 Rosca M8 x 1.25 L=27,2	(028.145.278.E) INA F-214797 VKM 31004
1592		DISTRIBUCION	POLEA MOVIL AUDI 80 1.9D SEAT CORDOBA, IBIZA, TOLEDO 1.9D	Polea Ø72 x 26 L= 43	(068.109.243.F) INA F-87936 VKM 11010 F-222095.01
1594		DISTRIBUCION	Polea Guía Fija de SEAT CORDOBA, IBIZA, TOLEDO 1.9D (AEF) 1.9 TDI/SDI AUDI 80, A4, S4, A6, S6, COUPE MOTORES 1.7D y 1.9D/SDI/TDI	Ø29 x 29 x Ø8.3 L=31.5 mm	(028.109.244) INA F-217278.1 VKM 21012 F-222651
1598		DISTRIBUCION	AUTOTENSOR SEAT Alhambra/ Cordoba/ Ibiza II/ Inca/ Toledo 1.9 D (AEF)/ 1.9 TDI/SDI/ 2.0 AUDI A4 / S4 / A6 / S6 1.9 TDI	Ø66.8 x 26 L=37.8 mm	(028.109.243F) INA F-232486 VKM 11014
1599		DISTRIBUCION	AUTOTENSOR SEAT Cordoba/ Ibiza II/ Inca/ Toledo II/ Leon 1.9 SDI (AGP / AQM)/ 1.9 TDI AUDI A3 1.9 TDI EXENTRICA	Ø66.8 x 26 L=41,5 mm	(038-109243-F/G/N) INA F-232604 VKM 11030
1602		DISTRIBUCION	Polea Fija AUDI A3- A4 / Seat Cordoba - Inca - Toledo 1.9 TDI - SDI AGR/AHF/ALH/AQM/ASV	Ø28.3 x Ø8.3 x 29	(58109244) INA F-227242 VKM 21004 F-140066
1603		DISTRIBUCION	Polea Fija Audi A4-A6 1.9 TDI AJM/ANU/ATD/AXR/ARL/ASZ	Ø28.3 x Ø8.3 x 34	(045109244A XM216K297AA) INA F-234845 VKM 21142









Artículo Article		Modelos que reemplazan Models that they replace	Dimensiones Dimensions	Equivalencias Equivalences
1604		Polea Fija SEAT CORDOBA/ IBIZA/ 1.9 TDI Y SDI / TOLEDO 1.9 TDI AUDI A3 1.9 TDI 97/04	Ø80 x 29 x Ø10 L=47,5	F-227243 VKM 21130 532011110
1605		Polea Fija AUDI A3 / A4 1.9 TDI ATD / AXR / ASZ SEAT CORDOBA / IBIZA 1.9 TDI AGR - ALH - ASV / 1.9 SDI ASY - AGP - AQM, LEON / TOLEDO 1.9 TDI 90 HP AGR- ALH / 1.9 TDI 110 HP AHF-ASV	Ø28.5 x 29 x 47	INA F-231223 VKM 21131 532016510
1606		Polea Fija AUDI A3 / A4 1.9 TDI ATD /AXR /ASZ SEAT CORDOBA / IBIZA 1.9 TDI AGR-ALH-ASV / 1.9 SDI ASY-AGP- AQM, LEON / TOLEDO 1.9 TDI 90 HP AGR- ALH / 1.9 TDI 110 HP AHF-ASV	Ø40 x 36 L=51mm	F-239652 VKM 21147 532034910
1607		Polea Fija AUDI A4, A5, A6, Q5 SEAT EXEO	Ø70,3 x 28 x Ø8 L=36mm	VKM 31008 GATES T36248 INA 532046810 F-552285 F-236326
1608		Autotensor SEAT CORDOBA 1.4	Ø62 x 22 L=50 mm	F-550812 VKM 11107 531052530
1610		Polea Sola A4 (02) 2.5 TDI A4 (01) 2.5 TDI A6 (98) 2.5 TDI A8 2.5 TDI	Ø76 x 25 x Ø17	Polea Sola INA F-550491 VKM 31039
1612		Tensor AUDI A3; A4 1.8 Y 1.8 Turbo TT 1.8 20v SEAT Leon y Toledo 1.8	Ø29 x 27	INA 125069 VKM 21115 531075130
1612P		Polea Recambio Tensor AUDI A3; A4 1.8 Y 1.8 Turbo TT 1.8 20v SEAT Leon y Toledo 1.8	Ø29 x 27	Polea Recambio INA 125069 VKM 21115 531075130
1613		Autotensor SEAT Ibiza 1.0; Ibiza 1.4 Inca; Ibiza; Córdoba y Toledo 1.6	Ø62 x 22 L=50 mm	INA 232489 VKM 11106 531025230

Artículo Article	Modelos que reemplazan Models that they replace	Dimensiones Dimensions	Equivalencias Equivalences
1614 	DISTRIBUCION Autotensor AUDI A3 y A4 1.9T SEAT Córdoba; Ibiza; León y Toledo 1.9TDI	Ø68 x 31 L=48 mm	INA F-551286 VKM 11250 T43191
1615 	DISTRIBUCION Autotensor AUDI A3 (00'/04'/08') 1.6 SEAT Córdoba; Ibiza; León, Toledo 1.6	Ø72 x 25 L=40 mm	INA F-560261 (ex F-123814) VKM 11113
1616 	POLY V Tensor Automatico Audi A4 2.0 TDI CAG / A4 1.9 TDI / Q5 2.0 Tf51 SEAT Ibiza 1.9 TDI / Altea / León / Toledo 2.0TDI	Ø70 x 24 L= 95 mm	534016410 T38427 VKM 31058
1619 	DISTRIBUCION Autotensor SEAT Altea, León 2.0 Tdi AUDI A3 2.0 140 CV TDI A4 2.0 143 CV TDI Q5 2.0 170 CV TDI	Ø68 x 26 x Ø8 L= 46 mm	Bosh 1987947477 T43216 F-577090 531082510 VKM 11269









Artículo Article		Modelos que reemplazan Models that they replace	Dimensiones Dimensions	Equivalencias Equivalences
1270		ROD.VENTILADOR Rodamiento ventilador Chevrolet S10 2.8 TD 4x2 L	Ø40 x Ø20 x 45 L=72	OEM 12642787
1431P		POLY V POLEA SOLA DE AUTOTENSOR CORSA II 1,8 8V. MERIVA 1,8 8V.	Ø68.5 x Ø17 x 25	POLEA SOLA VKM 04752 DAYCO DYV763
1432		DISTRIBUCION VECTRA 2.2 16V. Y 2.4 16V, OMEGA 2.2 16V ZAFIRA 2.0 16V NAFTA	Ø54 x 27 X Ø10	INA F-231413 VKM 25224
1433		DISTRIBUCION AVEO 1.6 16V SONIC 1.6 16V	Ø64 x 29 L=33.5mm	INA F-227728 VKM 80000 532019420
1442		POLY V POLEA FIJA CORSA 1.0 / ZAFIRA 2.0 /ASTRA / VECTRA 1.8 - 2.0 8V y 16 V /CORSA. TODOS CON AA; S-10 MOTO MWM	Ø69,5 x Ø8 x 26	VKM 34034H T 36175 532050110
1453		POLY V Tensor Fijo para correa Poly-V DE ACCESORIOS ASTRA, VECTRA 1.8 y 2.0 8V.y 16v, CORSA todos c/AA S10 MOTOR MWM (90500229 / 1340541)	Ø69.5 x 26 x Ø17	INA F-235783 VKM 34034 VKM 60001 532050110
1455		POLY V Polea Fija de ACCESORIOS ASTRA, CORSA 1.6 s/AA y s/DH, VECTRA 1.6 2.0 8V Y 16V NYLON	Ø70 x 25.5 x Ø17	(90411025 1340533) VKM 33043 VKM 04839 534007520
1465		DISTRIBUCION Polea Fija S10, BLAZER MOTOR MAXION HS 2.5 D/TD desde 11/97'	Ø64.5 x 35 L=43 mm	F-49322.3 F-49165.41 (ETC 8560 A) INAF-140070.1 VKM 27405H 532013610
1466		DISTRIBUCION Tensor Móvil para correa de distribución S10, BLAZER MOTOR MAXION HS 2.5 D/TD desde 11/97'	Ø67 x 38 L=44.3 mm	(ERR 1972 A) INA F-140564.1 VKM 17405H









Artículo Article		Modelos que reemplazan Models that they replace	Dimensiones Dimensions	Equivalencias Equivalences
1467		POLY V AUTOTENSOR de ACCESORIOS MOTOR MAXION 2.5 TDI S10 / Blazer / Silverado 97 2.5 D/TD HS-Maxion	$\varnothing 85 \times 32 \times \varnothing 17$ L=100 mm	T 38425 534011720 (ERR 4708) VKM 37420 VKM 04781 F-236649
1467P		POLY V Polea Fija de ACCESORIOS MOTOR MAXION 2.5 TDI - S10 / Blazer / Silverado 97' 2.5 TD HS - Maxion POLEA SOLA	$\varnothing 85 \times 32 \times \varnothing 17$	Polea sola (ERR 4708) VKM 37420 VKM 04781
1471		POLY V Tensor de ACCESORIOS ASTRA, CORSA 1.6 c/AA y s/DH, 1.4 / 1.4 16v / 1.6 / 1.6 16v NYLON	Polea $\varnothing 75 \times 26$ L=30.2 mm	(90409238) INA F-224134 VKM 35002
1472		DISTRIBUCION Tensor para correa de ACCESORIOS S10, D20, C20, SILVERADO MOTOR MWM - 6 CILINDROS	Polea $\varnothing 80 \times 32$	(MWM3801) INA F-123142 VKM 26501
1473		DISTRIBUCION POLEA FIJA CORSA / CORSA COMBO / TIGRA Motor: 1.6 XE Nafta VECTRA Motor: 2.0 16v N y Turbo / ASTRA Motor: 2.0 16 v Motor C20XE VECTRA ASTRA 2.0 16v	$\varnothing 63 \times 30 \times \varnothing 8.2$	(636416) INA F-224966 VKM 25213
1474		DISTRIBUCION POLEA FIJA ASTRA /CORSA / COMBO /TIGRA Motor: 1.6 16v ASTRA Motor 1.6 16v X16XEL y 1.8 16v X18XE2 CORSA 1.4-1.6 VECTRA ZAFIRA 1.8-2.0 16v SUPERIOR NYLON	$\varnothing 53 \times 26 \times \varnothing 8.25$	(90412731) (5636415) INA F-224967 VKM 25150
1475		DISTRIBUCION POLEA FIJA CORSA / CORSA COMBO TIGRA Motor: C 1.6 XE Nafta VECTRA Motor: 2.0 16 v N y Turbo ASTRA Motor: 2.0 16 v motor X20XE y C20XE ASTRA 1.8 CORSA 1.6 VECTRA 1.8-2.0 16V - NYLON	$\varnothing 53 \times 29.5 \times \varnothing 8$	(636415) INA F-224964 VKM 25212
1476P		POLY V POLEA RECAMBIO SILVERADO S-10 (12/13)	$\varnothing 76 \times \varnothing 10 \times 30$	
1477		DISTRIBUCION Tensor Automático Astra 1.8-2.0 Vectra 2.2 16v / Vitara 2.2 16v Zafira 2.0 / S10 2.2 EFI / MPF Corsa 1.8 8v 05/..	$\varnothing 59 \times \varnothing 8.1 \times 22$ L=32.5 mm	(5636429 636727) INA F-234394 VKM 15402

Artículo Article		Modelos que reemplazan Models that they replace	Dimensiones Dimensions	Equivalencias Equivalences
1478		DISTRIBUCION Tensor Automático CORSA / CORSA COMBO / TIGRA 1.6 XE Nafta Astra/Zafira/Meriva 1.6 16V X16XEL 1.8 16V X18XE1 Corsa / Astra 1.4-1.6-1.8 16v VECTRA 1.8 16v DOHC	∅59 X ∅8.1 X 22 L=34.5 mm	(636739) (5636732) (5636733) INA F-232481 VKM 15216
1479		DISTRIBUCION Tensor automático CORSA / CORSA COMBO / TIGRA Motor: 1.6N CORSA 8V MOTOR 1.3 SOHC CORSA 1.2-1.4-1.6 ASTRA 1.4-1.6 8v VECTRA 1.4-1.6	∅59 X ∅8.1 X 19 L= 31 mm	(636734) (5636721) INA 232482 VKM 15121
1480		DISTRIBUCION Tensor Automático VECTRA, ASTRA, MERIVA, FRONTERA MOTOR 1.8 16V 2.0 16V Y 2.2 8V	∅59 X ∅8.1 X 26 L=33.5 mm	(636737 636726) INA F-232488 F-232481.01 VKM 15202
1483		POLY V CHEVROLET ASTRA, CORSA 1.4 1.6 y 1.8 con A/A	∅70 x 26 L=95	VKM 35009 GATES: T38154 213/403 INA 531029430 534011820 531049230
1483P		POLY V POLEA DE RECAMBIO CHEVROLET CELTA y CORSA 1.4 8v CORSA 1.6 8v	∅70 x 26	Polea sola para: VKM 35009
1484		POLY V CHEVROLET S10	∅85 x 23	T36130 VKM 34299 H VKM 60005 F-44818.2
1486		POLY V CHEVROLET ASTRA, CORSA II MOTOR 1.8	∅76 x 22 x ∅17	90571758 VKM 04810
1537		POLY V CHEVROLET GRAN VITARA 2.0 HDI	∅70 x 25 L=67,5 MM	T38237 - T38392 F-236666 534011020 VKM 33033
1537P		POLY V POLEA RECAMBIO TENSOR GRAND VITARA 2.0 HDI	∅70 x 25	POLEA RECAMBIO VKM 33033 T 38237 T 38292 F-236666 534011020

Artículo Article		Modelos que reemplazan Models that they replace	Dimensiones Dimensions	Equivalencias Equivalences
1610		POLY V Corsa II 1.7 TD y 17DT Mtr. Isuzu Meriva 1.7 TD y 17DT Mtr. Isuzu	Ø76x25xØ17	INA F-550491 VKM 31039
1620		DISTRIBUCION CONJUNTO MAXION MOTOR MAXION HS 2.5 MOTOR MAXION 2.8 POWER STROKE (Contiene tensor fijo 1465; móvil 1466 y rueda dentada 1621) HS 500	Ø65 x 35 x 43 Ø67 x 38 x 44 Ø71,5 x 32 x 47 Kit de tres piezas (1465T- 1466T - 1621T)	VKMA 07405 AC c/ engranaje cigüenal
1621		DISTRIBUCION Engranaje Fijo S10, SILVERADO 97, BLAZER MOTOR MAXION HS 2.5D, 2.8D Y 3.0 POWER STROKE (CIGUEÑAL)	Ø71.5 x 31.8 x 47.3	VKM 17410HERR 100660
1630		POLY V BLAZER, S10 motor MWM 2.8 TDI 4 cil	Polea Ø 69.5 x 26 L=42 mm	F-562565 (94070341007A) VKM 60013 Litens 7068
1631		DISTRIBUCION LUV 2.5 / 2.8TD y 3.1TD	Ø67 x 38 L= 43 mm	VKM 79002 531015020
1634		DISTRIBUCION LUV 2.5D y 2.8TD	Ø67 x 38.5 dist. al apoyo 41 mm	INA 532007620 VKM 89003
1641		DISTRIBUCION CHEVROLET AVEO, CRUZE 1.6 16v	Ø60 x 29 L= 50	VKM70000 1987949904 T43039 531021330 F-237801
1645		DISTRIBUCION Autotensor distribución CHEVROLET Tracker, Cruze 1,8 16V - Sonic 1.6 16V	Ø66 x 29 L= 47	VKM 15260 531077910 T 43143
1647		POLY V TENSOR MÓVIL POLI-V CHEVROLET S-10 2.8 TD 4X2 LS MOD. 2016/17/18	Ø70 x 28 L= 84	OEM24582056

Artículo Article		Modelos que reemplazan Models that they replace	Dimensiones Dimensions	Equivalencias Equivalences
1420		ROD.VENTILADOR JUMPER 2.8 D 99/05	Ø67 X Ø25 X 34	VKM 22385 VKM 12380 532023920 F-113338 T 41178
1421		DISTRIBUCION TENSOR CITROËN JUMPER 2, 8D 99/05	Ø64,5 X Ø25 X 34	VKM 22380 531055710 F-113339 T41234
1422		DISTRIBUCION TENSOR CITROËN C3 1.3 16 V / PICASSO / XSARA X5 1.6 16V	Ø56 x Ø8 x 32	VKM 23130 532014210 F-122574 T42066
1445P		POLY V Tensor para correa Citroen C3 1.4 HDI Polea sola	Ø56,5x Ø17 x25.5	Polea sola 534018010 VKM 33061
1468		DISTRIBUCION C3 1.4 HDI C4 PICASSO 1.6 HDI 16V BERLINGO II 1.6 HDI	Ø60 x 30 x Ø10	532032110 F-123906 VKM 23140 T42162
1491		POLY V Tensor Móvil DE ACCESORIOS BERLINGO, BX, XANTIA, XSARA,ZX, EVASION, JUMPER MOTORES XUD7 1.8D - 1.9D /TD XUD9AU/TE/TSU - 2.1D	Polea Ø85x26 L=34 mm	(9607451480 5751.38) INA F-123000 F-121208.4 VKM 33002
1492		POLY V Tensor Móvil ZX / Xantia Motor 1.8 D XUD7 /1.9 D/TD XUD9A/TE	Polea Ø60x28 L=107 mm	(96199932 5751.23) INA F-123736 VKM 33040
1493		DISTRIBUCION Tensor Fijo C15 / ZX / Xsara / Xantia Berlingo / Jumper (94)/ MOTORES XUD1.8D XUD7-1.9D desde 01 94 TD XUD9 / XUD9T	Polea Ø60x35 L=45.5 mm	(9615923380 0830.13) INA F-122980 VKM 23241
1494		DISTRIBUCION Tensor Fijo BERLINGO, XANTIA,XSARA, ZX MOTORES XUD 1.8D-1.9D desde 01/'94 BX / C15 / ZX Motor 1.9 D XUD9	Polea Ø60x35 L=45.5 mm	(9350110580 0830.02) INA F-123369 VKM 23240

Artículo Article		Modelos que reemplazan Models that they replace	Dimensiones Dimensions	Equivalencias Equivalences	
1495		POLY V	Tensor Móvil DE ACCESORIOS ZX Motor: 1.6 / 1.9	Polea Ø85x22 L=38.5 mm	(6453.76) INA F-38931.4 VKM 33010
1497		DISTRIBUCION	Tensor Móvil BERLINGO, XANTIA, XSARA, ZX, BX, C15 MOTORES XUD9 1.8D-1.9D hasta 01/'94	Polea Ø60x35 L=45.5 mm	(0829.11) INA F-122051 VKM 13240
1498		DISTRIBUCION	Tensor MOVIL BERLINGO, XANTIA, XSARA, ZX, C15, JUMPER MOTORES XUD7 1.8D-1.9D desde 01/'94/ TD XUD9 / XUD9T	Polea Ø60x35 L=45.5 mm	(0829.33) INA F-122216.3 VKM 13241
1501		POLY V	Tensor Fijo c/Soporte Fundición XANTIA 1.9D-2.1D, ZX 1.8D-1.9D Evasión / Xsara / Berlingo / Jumper 1.8 D XUD7 / 1.9 D/TD XUD9A/TE	Polea Ø60x28 L=46 mm	(96501545 5751.24) INA F-122544 VKM 33008
1502		POLY V	Polea Recambio de tensor fijo XANTIA 1.9D-2.1D, ZX 1.8D-1.9D Evasión / Xsara / Berlingo / Jumper 1.8 D XUD7 / 1.9 D/TD XUD9A/TE	Polea recambio Polea Ø60x28 L=45,5	Polea recambio (96501545 5751.24) INA F-122544 VKM 33008
1503		POLY V	Polea Fija de ACCESORIOS BX 1.8D-1.9D NYLON	Ø70 x 25.5 Rosca M12x1.25 L=28 mm	(5751.14) INA F-121373.1 VKM 33006 F-121194.4
1504		POLY V	Polea X/Berlingo/Xsara/Xantia Motor: 1.6 / 1.8 / 2.0 / 1.9 D /TD / 2.0 16v NYLON	Ø90 x 25 x Ø17	(5751.20) INA F-224669 VKM 33034 VKM 03011 F-123749
1505		DISTRIBUCION	Tensor Móvil XANTIA 2.0 16V XU10J4, ZX 2.0 16V	Polea Ø60x30 L=42 mm	(91538722) INA F-120726 F-37269 VKM 16200
1506		DISTRIBUCION	Tensor Excéntrico Móvil BX 1.9 16V, XANTIA 2.0 16V, ZX 2.0 16V/MOTOR XU9J4, XU10J4	Polea Ø56x31 L=41 mm	(91538722 0829.20) INA F-120046.4 VKM 13210

Artículo Article		Modelos que reemplazan Models that they replace	Dimensiones Dimensions	Equivalencias Equivalences
1507		POLY V Tensor Móvil DE DIREC. ASISTIDA JumperMotor 2.5 D / TD DJ5/DJ5T/DJ5TED	Polea Ø94x26 L=32.5 mm	(96155001 4007 E4) INA F-121977.1 VKM 33015
1508		POLY V Tensor Excéntrico Móvil de ACCESORIOS : Xantia / Xsara / XM / ZX / Evasion / Xsara Picasso /Berlingo / Jumpy / C5 / C8 MOTOR 1.9 D / TD XUD9A / DW8 / 2.0 Hdí DW10 TD/ATED / 2.1 TD XUD11BT	Polea Ø69,5x27 L=29 mm	(961888580 5751.29) INA F-122662 VKM 33013
1509		POLY V Tensor Móvil DE ACCESORIOS BERLINGO, XANTIA, XSARA, ZX, Evasión, Jumpy, XM MOTOR 1.9 D DW8, DW8B / 2.1 TD XUD11BTE, XUD7, XUD9	Polea Ø60x27 L=92,5mm	(5751.30) INA F123787 VKM 33029
1509P		POLY V Polea de recambio tensor movil BERLINGO, XANTIA, XSARA, ZX, Evasión, Jumpy, XM MOTOR 1.9 D DW8 / DW8B / 2.1 TD XUD11BTE, XUD7, XUD9	Polea Ø60x27 L=27 mm	Polea recambio (5751.30) INA F-123787 VKM 33029
1510		DISTRIBUCION Tensor Excéntrico Móvil AX / Berlingo / BX / C15 / Evasión / Saxo / Xantia XM / Xsara / Xsara Picasso / ZX Motor: 1.1 TU1JP / 1.4i TU3JP / 1.6 TU5JP / 1.8 XU7JP / 2.0 XUJ2C	Polea Ø60x22 L=32.7 mm	(9605266280 0829.19) INA F-121287.5 VKM 13100
1511		POLY V Tensor Móvil de ACCESORIOS BERLINGO, XSARA 98/05 MOTOR DW8 / DW8B 1.9D	Polea Ø85x26 L=34,25 mm	(9629471780 5751.45) INA F-123305.1 VKM 33004
1512		DISTRIBUCION Tensor Excéntrico Móvil Berlingo / C5 / C8 / Evasión / Jumper / Jumpy Xantia / Xsara / Xsara Picasso 99/.. Motor: 2.0 HDi DW10TD / DW10ATED /ATED4 / 2.2 HDi DW12TED4	Ø 60 x 34 x 40.9	(0829.59) INA F-122985.51 VKM 13246
1513		POLY V Tensor Berlingo / Jumpy / Xsara Motor 1.9 D DW8 51 KW	Ø38 x Ø10 x 27 L=28mm	(5751.46 5751.63) INA F-123880.2 VKM 33017
1514		DISTRIBUCION Polea Fija Berlingo / C5 / C8 / Evasión / Jumper / Jumpy Xantia / Xsara / Xsara Picasso 99/.. Motor 2.0 HDi DW10TD / DW10ATED / ATED4 / 2.2 HDi DW12TED4	Ø60 x Ø10 X 31 L=41mm	T 42065 T 42070 (0830.28) T 42161 VKM 23122 VKM 23246 F-122124









Artículo Article		Modelos que reemplazan Models that they replace	Dimensiones Dimensions	Equivalencias Equivalences
1515		DISTRIBUCION Tensor Citroen XsaraBerlingo 1.9HDI, Xantia 2.0 HDI	Polea Ø60x30 L=40 mm	(0829.60) INA F122985.51 VKM 13244 F-123326.08
1516		DISTRIBUCION Tensor Citroen Xsara motor XU7JP4 Y XU10J4R, Xantia MOTOR 1.8 16vy 2.0 16v	Polea Ø56x29 L=40 mm	(0829.32) INA F-122868 F-122056.2 VKM 13202
1517		DISTRIBUCION Tensor para correa Citroën:Xsara 1.8 16V EW7J4 '00/'03 Xsara 2.0 16V EW10J4 '00/'03 Xsara Picasso 1.8 16V EW7J4 '00/'03 Xsara Picasso 1.8 16V EW10J4 '00/'=> (9660098680) (0830.42)	Polea Ø60x30xØ10 L=37 mm	(9660098680) (0830.42) INA 532028910 VKM 23230 F-124276.1 T 41235
1518		DISTRIBUCION Tensor para correa Citroën Berlingo 1.6 16V TU5JP4 '00/'02 Xsara 1.6 16V TU5JP4 '00/'04	Polea Ø60x30 L=39mm, Ø int. 8.25mm	(0829.A1) (0830.62) INA F-122574.5 532039510 532014210 VKM 23256
1519		POLY V Polea Nylon de Accesorios Citroën Xsara 1.9 D DW8	Ø60 x 25 L=28 mm	(5751.73) INA F-236667 VKM 33031
1519P		POLY V BERLINGO1.9, XANTIA 1.9 XSARA 1.6, XSARA PICCASO 1.9V	Ø60 x 25 Polea sola	Polea recambio tensores VKM 33031 VKM 33032 VKM 33101 VKM 36020
1520		DISTRIBUCION Polea Fija Citroën Xsara - ZX -Evasion - XM 2.0 16v XU10J4R - RS	Ø60 x 28.5 L=39 mm	0830.36 0830.37 083016 INA F-122124.51 VKM 23213
1521		DISTRIBUCION TENSOR C5 - XSARA 2.0 16v EW10J4	Polea Ø 62 x 30 L=37.5mm	INA F-125081 VKM 13234
1522		DISTRIBUCION Tensor C3 1.6 16V TU5JP4, Sara XS Picasso 1.6 16V motor 1806404 MACIZO	Ø56 x 32 L=40mm	(0830.20 - 0830.61) INA F-122574 VKM 23130









Artículo Article		Modelos que reemplazan Models that they replace	Dimensiones Dimensions	Equivalencias Equivalences
1523		POLY V Berlingo 2.0 HDI con aire acond. C4 y C5 2.0 HDI Xantia; Xsara y Xsara Picasso 2.0 HDI	Ø50 X 26 doble pista	INA 532014310 F-122530 VKM 33069 T 36151
1524		DISTRIBUCION C4 2.0 HDI C5 2.0 HDI	Ø60x30 L=41mm	T42199 INA F-124178 VKM 23257
1525		POLY V BERLINGO 1.9D 2.0HDIC4 Y C5 2.0HDI XSARA 1.9D 2.0HDI XSARA PICCASO 2.0HDI	Ø70x25. L=27 mm	F-236662 INA F-571057 VKM 33045
1526		DISTRIBUCION C3 y C4 1.6 16V. Xsara y Xsara Picasso 1.6 16V.	Ø73 x 31 L=41 mm	INA F-232829.4 VKM 13132
1527		DISTRIBUCION AX 1.5D - SAXO 1.5D	Ø59 x 28,5 L=39	VKM 13120 F-120447.2 531003110 T 41130
1528		POLY V Xsara 1.6 16v; Xsara Picasso 1.6	Ø70 X 27 L=29mm	F-123259.1INA F-122332 VKM 33023
1529		POLY V CITROËN C3,C4 POLY V	Ø65 x 26 x Ø17	VKM 31303 GATES T36376 INA 532055710 F-561582.04 F-576987 F-237268.04 F-553814.03
1529P		POLY V POLE SOLA CITROËN C3, C4 POLY V	Ø65 x 26 x Ø17	VKM 31303 GATES T36376 INA 532055710 F-561582.04 F-576987 F-237268.04 F-553814.03
1530		POLY V TENSOR CORREA CITROËN C3 / BERLINGO 1.4 HDI	Ø60 x Ø10 x 30 L=46	VKM 33131 532053810 F-123934.17 T36295









Artículo Article		Modelos que reemplazan Models that they replace	Dimensiones Dimensions	Equivalencias Equivalences
1531		POLY V CITROËN C3 MOTOR 1.4	Ø30 x 31 x Ø10 L= 46mm	F-122285.6 F-123934 VKM 33044 GATES T36034 INA 532032010
1532		POLY V CITROËN BERLINGO, XSARA 1.6	Ø60 x 31 x Ø10	VKM 33100 GATES: T36190 INA: 532033110
1533		DISTRIBUCION BERLINGO, C4, PICASSO 1.6 HDI (diesel) CITROËN C3 1.4 TDI	Ø60 x 29 L=39 mm	VKM 13140 GATES: T43158 INA 531055510 F-232828.08
1534		DISTRIBUCION CITROËN C3 1.4 y 1.5 CITROËN BERLINGO 1.4 BERLINGO II 1.5	Ø60 x 26 L=33,5 mm	Bosch987949893 T 43023 - T 43062F- 125042 531057210 VKM 13253
1535		POLY V CITROËN BERLINGO XSARA 1.9 DIESEL DW8	Ø60 x 26 x Ø17 L= 66,5mm	VKM 03030 VKM 33032 GATES: T38236 INA 531042210 F-236668
1535P		POLY V CITROËN BERLINGO, XSARA POLEA RECAMBIO: 1535 1646	Ø60 x 25 Polea reparación	Polea reparación: VKM 33032 T-38236 531042210
1536		DISTRIBUCION CITROËN C4, C5 2.0 16V, C4 PICASSO, C5 II, C8	Ø62 x 29 L=38	T 43145 VKM 13263 531077010
1537		POLY V CITROËN BERLINGO, C4, XARA 2.0HDI, C4 2.0 16V HDI DIESEL	Ø70 x 25 L= 67mm	T38156 - T38392 F-236666 534011020 VKM 33033
1537P		POLY V CITROËN BERLINGO, C4, C5, XANTIA 2.0 POLEA RECAMBIO CONJUNTO 1537	Ø70 x 25.5 Polea reparación	Polea recambio VKM 33033 T38392 F-236666 534011020

Artículo Article		Modelos que reemplazan Models that they replace	Dimensiones Dimensions	Equivalencias Equivalences
1538		POLY V CITROËN BERLINGO 1.4, XSARA 1.4 CON A/A 1.6 16V CON A/A, XSARA PIZASSO	Polea Ø60 x 26 L= 89 mm	534017910 VKM 33101 T39055
1539		DISTRIBUCION CITROËN C4 LOUNGE, GRAND PICASSO, BERLINGO 1.6 HDI	Ø61 x 30 x Ø10	F-574745.08 F-583430 VKM 23121 T42307
1540		POLY V POLEA DE INVERSION CITROËN C5, C5 Breack, XSantia, XSantia Breack 3.0 V6	Ø65xØ8x26.5	VKM 33075 INA 53063110 T36451
1571		POLY V POLEA FIJA ALTERNADOR CITROËN JUMPER 2.8 D, TD y HDI	Ø60 x Ø8.4 x 26	INA 532036720 VKM 36017 F-562368.1
1644		DISTRIBUCION AUTOTENSOR C3 / C3 PICASSO / C3 AIRCROSS / C4 / X ZARA / XZARA PICASSO / BERLINGO MOTOR 1.6 VTI - 1.6 16V	Ø70 x 30 L= 40	VKM 13256 531063210 F-232828.5 T43159
1646		POLY V TENSOR AUTOMÁTICO C3 / CE PICASSO / C4 / C3 AIRCROSS - XSARA / XSARA PICASSO / BERLINGO 1.6 16V	Ø30 x 26 L= 69	VKM 33036 534044710 T39126 APV 2556
1652		POLY V POLEA RECAMBIO TENSOR CITROËN C3 - C4 / XSARA / BERLINGO 1.6 16V	Ø70 x Ø10 x 27 L= 39	VKM 33018-1 531030610 F-122748-4T 38232
1801		POLY V CITROËN BERLINGO, XSARA 1.9D, C6 3.0 V6	Ø31 X 130	T38407 F-123788 F-124058 53300110 533001110 VKM 33311

Artículo Article		Modelos que reemplazan Models that they replace	Dimensiones Dimensions	Equivalencias Equivalences
1433		DISTRIBUCION Tensor de correa Cielo 1.5; Espero 1.5 Nubira 1.6; Lanos 1.5 - 1.6	$\varnothing 64 \times 29$ L=33.5 mm	INA 227728 VKM 80000 532019420
1479		DISTRIBUCION Tensor Automatico DAEWOO CIELO 1.5 - 1.8 NUBIRA 1.5 ESPERO Motor: 1.5 MPI - 1.6 LGP 1.8 - 2.0 - 2.2	$\varnothing 59 \times \varnothing 8.1 \times 19$ L=31 mm	(636734) (5636421) INA 232482 VKM 15121
1480		DISTRIBUCION Tensor Automático Daewoo Nubira / Leganza Motor: 1.8 / 2.0 / 2.2	$\varnothing 59 \times \varnothing 8.1 \times 26$ L=33.5 mm	(636737 636726) INA F-232488 F-232481.01 VKM 15202
1639		DISTRIBUCION CHERY TIGGO 2.0 Tensor guía	$\varnothing 28,5 \times 27 \times \varnothing 17$ L= 40,5mm	N° Original 481H1007070
1640		DISTRIBUCION CHERY TIGGO 2.0 Tensor fijo	$\varnothing 60 \times 30 \times \varnothing 17$ L= 42mm	N° Original 481H1007070
1641		DISTRIBUCION Tensor de correa DAEWOO CIELO, ESPERO, LANOS 1.6 16v	$\varnothing 60 \times 29$ L= 50mm	VKM 70000 1987949904 T43039 F-237801 531021330
1653		DISTRIBUCION Tensor distribucion Chery QQ 1.1	$\varnothing 50 \times 27$ L= 31,5 mm	OEM3721007030 ATB2586

Artículo Article		Modelos que reemplazan Models that they replace	Dimensiones Dimensions	Equivalencias Equivalences
1400		DISTRIBUCIÓN Tensor Movil 128 MOTOR 1.1-1.3	Ø60 x 27 x Ø25	(4320893) VKM 12103 INA 531072800 F-123635
1401		DISTRIBUCIÓN Tensor móvil DUNA; UNO; SPAZIO; VIVACE; BRIO; 147 Motor: 1.1 N DUNA; UNO; SPAZIO; VIVACE; BRIO; 147 Motor: 1.3 N 128; EUROPA; SUPEREUROPA Motor: 1.1; 1.3 N 128 EUROPA y SUPER EUROPA 1.3	Ø60 x 29 x Ø25	(4320893) (4027068) (438558) (4385583) INA F123634 VKM 12100 531072820
1402		DISTRIBUCIÓN Tensor móvil DUNA 1.5, UNO 1.5 60-75, FIAT 128 SE, REGATA 85 1.5, REGATA 1.6	Ø56 x 29 x Ø25	(4386575) INA 123631 VKM 12003
1403		DISTRIBUCIÓN Tensor móvil TENSOR FIAT 125 / 131 Miraffiori Motor 1.6	Ø69,5 x 28 x Ø25	(4178014) VKM 12012 INA 531071520 T 41256
1404		DISTRIBUCIÓN Tensor fijo 147, UNO, DUNA, FIORINO SPAZIO MOTOR 1.3 DIESEL	Polea Ø57x26 L=38 mm	(5952181) INA F45605 VKM 22630
1405		DISTRIBUCIÓN Tensor móvil DUNA ; UNO ; SPAZIO; VIVACE; BRIO; 147 Motor: 1.3 D FIORINO Motor: 1.3 D	Polea Ø60x31 Distancia de Apoyo a Polea 41.5 mm	(4438894) INA F45442 VKM 12630
1407		DISTRIBUCIÓN Tensor móvil DUNA; UNO; SPAZIO; VIVACE; BRIO; 147 1.7 Y 1.7D FIORINO 1.7 D PALIO y SIENA 1.6 / 1.7D DUNA, UNO, PALIO, SIENA, FIORINO MOTOR 1.4-1.7 DIESEL	Polea Ø61x30 L=51.5 mm	F 123636 (7553564) INA 110590.1 VKM 12151
1408		DISTRIBUCIÓN Tensor FIJO DUNA; UNO; SPAZIO; VIVACE; BRIO; 147 1.7 D FIORINO 1.7 D PALIO y SIENA 1.6 / 1.7D DUNA, UNO, PALIO, SIENA, FIORINO MOTOR 1.4-1.7 D.	Polea Ø61x30 L=51.5 mm	F 123649 (7553565) INA 110591.1 VKM 22151
1409		DISTRIBUCIÓN Tensor móvil DUNA/ UNO/ SPAZIO/ VIVACE/ 147/ Regatta/ Fiorino/ Palio/ Siena Motor 1.4 / 1.6 Motor Tipo / 1.6 SPI / 1.3 Mpi	Ø56 x 24 x Ø30	F 113181 (5972277 / 7541718) INA F36261.3 VKM 12200



Artículo Article		Modelos que reemplazan Models that they replace	Dimensiones Dimensions	Equivalencias Equivalences
1410		DISTRIBUCIÓN Tensor Móvil Excéntrico 147 1.3-1.5, UNO 1.5, TIPO 16V REGATA 85 1.5, Regatta / Tempira / Tipo 1.8 / 2.0 8v-16v	Polea Ø56x27 L=39 mm	F-203093 (5997325) INA F220257 VKM 12101
1411		DISTRIBUCIÓN Tensor Móvil Excéntrico TEMPRA 2.0 / TEMPRA 2.0 16v / 1.8 TIPO 1.8ie / 2.0ie REGATTA 2.0 2000, TEMPRA 2.0 hasta AGOSTO de 1995	Polea Ø60x25 L=48 mm	F-123638 (7541718) INA 110273.2 VKM 12227
1412		DISTRIBUCIÓN Tensor Móvil Excéntrico REGATTA 85 100S Motor: 2.0 Motor Lancia TEMPRA Tipo 2.0 / REGATA 2.0 2000, 2.0 16v 1.8ie, TEMPRA 2.0 desde AGOSTO de 1995	Polea Ø60x25 L=50 mm	(7726935 5956109 60800148) INA 123633 VKM 12005
1413		DISTRIBUCIÓN Polea Fija TIPO 1.7D-1.9D, DUCATO 1.9D-2.5D, BRAVO 1.9D, BRAVA 1.9D TEMPRA 1.9D/TD	Polea Ø61x33 L=57 mm	(7596727) INA 123650 VKM 22153
1414		DISTRIBUCIÓN Tensor Móvil Excéntrico TIPO 1.7D-1.9D, DUCATO 1.9D-2.5D, BRAVO 1.9D, BRAVA 1.9D TEMPRA 1.9D/TD	Polea Ø61x33 L=56.5 mm	(7596877) INA F123637 VKM 12153
1415		DISTRIBUCIÓN CAMIÓN FIAT 150 TURBO Y BUS (454-7718)	Ø30 x 38,8 L=67	
1416		POLY V Polea Fija DE AIRE ACOND. DUNA 1.7 Palio / Siena / Uno 1.7 D 97	Ø68 x 22 x Ø17	APV 2763 (Dayco) VKM 36002 T 36041
1417		POLY V Polea Fija TEMPRA 1.4-1.6-1.9, TIPO 1.4-1.6, UNO 1.4 - 1.7 D/TD, DUNA 1.7D, TEMPRA 1.9D, DUCATO 1.9D PALIO Y SIENA 1.7 D/TD	Ø80 x 23 x Ø20 (Metálica)	F-571947 (60805460) INA 110627.4 VKM 32009
1418		POLY V Polea Fija TEMPRA 1.4-1.6-1.9, TIPO 1.4-1.6, UNO 1.4 - 1.7 D/TD, DUNA 1.7D, TEMPRA 1.9D, DUCATO 1.9D PALIO Y SIENA 1.7 D/TD	Ø80 x 23 x Ø20 (Nylon)	F 123755 (60805460) INA 110627.4 VKM 32009 VKM 32242









Artículo Article		Modelos que reemplazan Models that they replace	Dimensiones Dimensions	Equivalencias Equivalences
1419		Polea Fija PALIO 1.7D/TD, SIENA 1.7D/TD STRADA 1.7 TD/TD	Ø80 x 17.5 x Ø20	(46740759 / 7749452) INA 110790 VKM 32011
1420		TENSOR MOVIL DAILY 2.5D, DUCATO 2.5D-2.8D	Ø67 x 34 x Ø25	(4740846) INA F113338 VKM 12380
1421		TENSOR DE CORREA FIJO DAILY 2.5D, DUCATO 2.5D-2.8D	Ø64.5 x 34 x Ø25	(4740847) INA F113339 VKM 22380
1422		Polea Fija PALIO, SIENA, BRAVO, BRAVA, MAREA MOTOR 1.6 16V TORQUE	Ø64.5 x Ø12 x 30.5 L=35.5 mm	(46400054) INA: F110628.3 VKM: 22242
1423		Polea Fija PALIO, SIENA, MAREA, BRAVO, BRAVA MOTOR 1.6 16V TORQUE	Ø64.5 x Ø12 x 35 L=38.5 mm	F-140070 VKM 27404 532008310 T 42152
1424		Tensor Fijo UNO, PALIO, SIENA, MAREA, BRAVA, BRAVO MOTOR 1.3 Mpi 8v y 16v / 2.0 20v - NYLON	Polea Ø79x26 L=28 mm	INA 532024110 (46440604) VKM 32005 F-110672_300
1425		Polea Fija PALIO, SIENA ALTERNADOR 1.3 MPI 8v	Ø81 X 26 X Ø17	(46524820) INA 123758 VKM 32299
1426		Polea Fija PALIO, SIENA ALTERNADOR FIRE 16V. 1.3 8v MPI	Ø66 X 23 X Ø17	INA 532029710 F-565352 (46756937) VKM 32031 T 36082
1427		Tensor Automático PALIO, SIENA MOTOR FIRE 1.3 16V	Ø60 x 29 L=42 mm	(46403679 46817666) INA 236854 VKM 12201

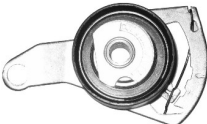







Artículo Article		Modelos que reemplazan Models that they replace	Dimensiones Dimensions	Equivalencias Equivalences
1428		Tensor Automático PALIO, SIENA, MAREA, BRAVO, BRAVA 1.6 16V MOTOR TORQUE	Ø60 x 29 L=38.5 mm	(46416489 4674298) INA 233127.1 VKM 12242
1429		Tensor Fiat Barchetta Coupe 1.8 16V	Polea Ø90x25 L=36 mm	(60812515 532036920) F-556664.02 T-36001 VKM 32001
1430		Tensor Móvil Excéntrico Fiat Palio - Siena - Uno - Fiorino 1.3 8v - Fire 03/..	Ø56X29	(46736886) 531081610 VKM 12299H F-110806.1
1431 P		POLEA SOLA DE AUTOTENSOR IDEA 1,8 8V. / PALIO PUNTO SIENA STILO 1,8 8V. HLX / STRADA , STRADA ADVENTURE 1,8 8V. CON AIRE ACOND.	Ø68.5X Ø17 X 25	POLEA SOLA VKM 04752 DAYCO DYV763 APV2897
1434		FIAT STILO / MAREA 1.9	Ø53 x 29 L=31,5 mm	532028710 VKM 22179 F-231511.07
1434 P		FIAT TORO / BRAVA / BRAVO STYLO 2.0 JTD / 2.0 JTD 16v	Ø53 x 17 x Ø29	532061110 VKM 22180
1435		FIAT GRAND SIENA / IDEA / PALIO / PUNTO / SIENA 1.4 8v Fire GRAND SIENA / PALIO 1.4 8v Fire	Ø56 x 26 x Ø8 L= 31 mm	Bosch 1987947477 T 43216 F-577090 531077810 VKM 12206 F-574537
1436		FIAT BRAVA / DOBLO / IDEA 1.4 8v Fire PALIO / SIENA 1.3 8v / 16v	Ø65 x 23 L=35 mm	VKM 32023 T38368 F236663 534006910
1436 P		FIAT PALIO / SIENA Fire 1.3 8v/16v FIAT BRAVA / DOBLO / IDEA 1.4 8v	Polea recambio Ø65 x 23	Polea sola para: VKM 32023 T 38368 F-236663 534006910

Artículo Article		Modelos que reemplazan Models that they replace	Dimensiones Dimensions	Equivalencias Equivalences
1437		DISTRIBUCIÓN FIAT 147 / BRAVA / MAREA / STILO 1.9 16v / TORO 2.0 JTD	Ø65 x 30 L=41 mm	VKM 12174 T-43211 T-43042 531025530 531084410 F-232477
1442		POLY V POLEA FIJA FIAT MAREA / BRAVA 1.6 16v	Ø69,5 x Ø8 x 26	VKM 34034 532050110 F-237433.01 T-36175
1477		DISTRIBUCIÓN Tensor Automático Palio / Siena 1.8 8v 05/..	Ø59 X Ø8.1 X 22 L=32.5 mm	(5636429 636727) F-234394 VKM 15402 531027330
1478		DISTRIBUCIÓN Tensor Palio / Siena 1.8 8v	Ø59 X Ø8.1 X 22 L=34.5 mm	(5636732 5636733 636739) INA F232481 VKM 15216
1486		DISTRIBUCIÓN FIAT STILO 1.8 8v - 16v 2.4 20v	Ø76 x 22 x Ø17	VKM 04810 90571758
1493		DISTRIBUCIÓN Tensor Fijo DUCATO 1.9 D / TD	Polea Ø60x35 L=45.5 mm	(9615923380 0830.13) INA F122980 VKM 23241
1498		DISTRIBUCIÓN Tensor MOVIL DUCATO Motor: 1.9 D / TD	Polea Ø60x35 L=45.5 mm	(0829.33) INA 122216.3 VKM 13241
1529		POLY V FIAT PUNTO	Ø65 x 26 x Ø17	VKM 31303 GATES T36376 INA 532055710 F-561582.04 F-576987 F-237268.04 F-553814.03
1529 P		POLY V FIAT PUNTO	Polea sola Ø65 x 26 x Ø17	VKM 31303 GATES T36376 INA 532055710 F-561582.04 F-576987 F-237268.04 F-553814.03.0300

Artículo <i>Article</i>	Modelos que reemplazan <i>Models that they replace</i>	Dimensiones <i>Dimensions</i>	Equivalencias <i>Equivalences</i>
1534 	POLY V FIAT CUBO 1.4	Ø60 x 26 L=33,5 mm	Bosch 987949893 T43023 - T43062 F-125042 531057210 VKM 13253
1538 	POLY V FIAT CUBO 1.4	Ø60 x 26 L=89 mm	VKM 33101 T 39055 534017910
1571 	POLY V ALTERNADOR POLEA FIJA DUCATO 2.8 TD Y DTI C/ A. ACOND. IVECO DAILY 35C, 50C, 60C 99/->	Ø60 x Ø8.4 x 26	F-562368.1 INA 532036720 VKM 36017 T36076
1572 	POLY V POLEA FIJA AIRE ACOND. FIAT DUCATO 2.5 D	Ø60 x Ø8.4 x 22	F 562369 VKM 36001 T 36040 532039920

Artículo Article		Modelos que reemplazan Models that they replace	Dimensiones Dimensions	Equivalencias Equivalences
1441		POLY V FORD FOCUS II 1.6 Sigma FIESTA KINETIK 1.6 16v Sigma 1.6 LTI - VCT Sigma ECOSPORT II 1.6 16v Sigma	Ø 65 x 26.5 L=35 mm	1987949981 T43171 - T43127 531026910 531058610 531081310 VKM 14224
1442		POLY V Polea Fija Ka (modelo nuevo) Ka Zatec, Mondeo Zatec Ford Fiesta, Focus, Ecosport 1.6	Ø69.5 x 26 x Ø8	VKM 34034 GATES T36175 INA 532050110 F-237433.01
1443		POLY V Mondeo 2.0 TDI Mondeo 2.2 TDCI JAGUAR X-Type M 2.0D /2.2D	Ø 65 x Ø 8 x 25.5 L=32mm	INA 532047010 VKM 34030 T 36124
1444		DISTRIBUCIÓN Autotensor Courier y Fiesta 1.6 16V, Focus 1.6 8V sin soporte de aluminio	Ø60 x 27 L=38.5mm	531026910 (98MM6K254BD) INA F550126 F 227194.1 531058610
1445		POLY V Tensor Ford Fiesta 1.4 D TDCI – Ecosport 1.4D TDCI	Ø56,5x Ø17 x25.5	Polea sola INA 534018010 VKM: 33061 T 38371
1446		DISTRIBUCIÓN Polea Fija Focus 1.6 16v - 1.8 16v - 2.0 16v / Ford Mondeo 1.8 16v - 2.0 16v	Ø60 x Ø8 x 29 L=47.5 mm	F-233879 (1095025 X57G6M250AA) INA F-550217 VKM 24213
1447		DISTRIBUCIÓN Tensor Automático Mondeo, Focus Motor Zetec E1.8 16v Y 2.0 16v, 1.6 / 1.6 16v	Ø60 x 29 L=47 mm	(988M6K254AC) INA F140931 VKM 14211
1448		DISTRIBUCIÓN Tensor Automático COURIER, Fiesta, Focus, 1.4 16v / 1.6 16v / ECOSPORT 1.6 8V Y 16V	Ø60 x 27 L=38 mm	(988M6K254BC) F 227194.2
1449		POLY V Tensor Móvil FIESTA, ESCORT, ORION, MONDEO 95, COURIER 1.8D. ENDURO 1.8D/TD	Ø 60 X 28 L=38 mm	(96FF6K254BA) INA F110937 VKM 14103

Artículo Article		Modelos que reemplazan Models that they replace	Dimensiones Dimensions	Equivalencias Equivalences
1450		DISTRIBUCIÓN Tensor Móvil (AUTOTENSOR) FIESTA, ESCORT, ORION, MONDEO 97, COURIER MOTOR KENT 1.8D/TD	Ø50 x 25.5 L=28.5 mm	(97FF6K254 CA) INA F234391 VKM 14107
1451		DISTRIBUCIÓN Tensor Móvil para correa de distribución ESCORT 2.0, SIERRA 1.8-2.0-2.3, TAUNUS desde 82'	Polea Ø47x28 L=36 mm	VKM 54001 (D4E6K254AD 70HM-6K254AD) INA F44573 531055210
1452		DISTRIBUCIÓN Tensor Móvil ESCORT, GALAXY, ORION MOTOR AUDI AP 827 1.6-1.8-2.0	Polea Ø72 x 24 L=28.5 mm	(056109243 D) INA F217668 VKM 11000 F 220093
1453		POLY V Polea Fija DE ACCESORIOS ESCORT DIESEL, FIESTA, KA, COURIER 1.8 D / TD / 1.6 16v / 1.8 16v	Ø69.5 x 26 x Ø17	INA: 235783 VKM 34034 VKM 60001 532050110
1454		POLY V Polea Fija Alternador de ACCESORIOS ESCORT, FIESTA, KA, COURIER 1.8 D / TD / 1.6 16v / 1.8 16v - NYLON	Ø75 x 22 x Ø17	INA 531054010 F-125052 (1004961) VKM 34005 T 38056
1455		POLY V Polea Fija DE ACCESORIOS FIESTA, ESCORT, KA, MONDEO, COURIER MOTOR KENT 1.8 D / TD / 1.6 16v / 1.8 16v NYLON	Ø70 x 25.5 x Ø17	(90411025 1340533) VKM 33043 VKM 04839 534007520
1456		POLY V Polea Fija Bba. Hidráulica DE ACCESORIOS ESCORT, FIESTA, KA, COURIER 1.8 D/TD NYLON	Ø61 x 22 x Ø17	INA 531053910 (1019323) VKM 34004 POLEA SOLA F-125049
1457		DISTRIBUCIÓN Polea Fija ESCORT, MONDEO, FIESTA, ORION, FOCUS, COURIER MOTOR ZETEC 1.6 Y 1.6 16V Zh16, 1.8 Y 1.8 16V, 2.0 Y 2.0 16V NYLON	Polea Ø60x29 L=30.5 mm	(6635942 / 928M6M250-BC) INA F140222 F212962.6 VKM 24210
1458		DISTRIBUCIÓN Engranaje Tensor Excéntrico (MOVIL) ESCORT, FIESTA, ORION, SIERRA, COURIER, MONDEO desde 01/'97MOTOR KENT 1.8D/TD	Ø56x25.4 L=27.9 mm	(1021707 / 97FF6K254DCDD) INA 140845.1 VKM 24107



Artículo Article		Modelos que reemplazan Models that they replace	Dimensiones Dimensions	Equivalencias Equivalences
1459		DISTRIBUCIÓN Engranaje Tensor FIJO ESCORT, FIESTA, ORION, SIERRA, COURIER, MONDEO desde 01/'97 (95/96) MOTOR KENT 1.8D/TD	Ø56x25.4 L=26.9 mm	(1005823 / 96FF-6K254AC) INA 140073.3 VKM 24100
1460		DISTRIBUCIÓN Polea Fija ESCORT, MONDEO, FIESTA, ORION, FOCUS, COURIER MOTOR ZETEC 1.6 Y 1.6 16V ZH16, 1.8 Y 1.8 16V ZH18 E, 2.0 Y 2.0 16V	Polea Ø48x28.6 L=28.9 mm	(6744307 / 928M-6M250-DC) INA F140223 VKM 24211
1461		DISTRIBUCIÓN Tensor Móvil ESCORT, MONDEO, FIESTA, ORION, FOCUS, COURIER MOTOR ZETEC 1.6 y 1.6 16v ZH16 / 1.8 y 1.8 16v ZH18 E / 2.0 y 2.0 16v - NYLON	Polea Ø86x30 L=49.3 mm	(6635942 / 948M-6K254-AC) INA 140221 VKM 14210
1462		DISTRIBUCIÓN Tensor Móvil ESCORT, FIESTA, ORION, SIERRA, COURIER, MONDEO hasta 01/'97 MOTOR KENT 1.8D/TD	Polea Ø52x25.5 L=28 mm	(1005516 / 96FF-6K254-AA) INA 140057.2 VKM 14105
1463		POLY V Polea Acanalada de ALTERNADOR RANGER 98 MOTOR MAXION Focus 1.8 16v / 2.0 16v NYLON	Ø67.5 x 26 x Ø17	INA F231069 VKM 31041
1464		DISTRIBUCIÓN Tensor Móvil SIERRA L 1.6-1.8-2.0, ESCORT 2.0, FIESTA 2.0, ORION 2.0, TRANSIT 1.6-2.0, GHIA 1.1 TL 16 OHC N	Polea Ø47x27 L=34 mm	(1496915 / 75HM-6K254-AA) INA F56900 VKM 14000
1465		DISTRIBUCIÓN Polea Fija F100 , RANGER 97', MAXION HS 2.5 D/TD desde 11/97', MAXION 2.8D Y 3.0 POWER STROKE	Polea Ø64.5x35 L=43 mm	F 49322.3 F 49165.41 (ETC 8560 A) INA 140070.1 VKM 27405H 432013610
1466		DISTRIBUCIÓN Tensor Móvil F100 , RANGER 97, MOTOR MAXION HS 2.5 D/TD desde 11/97', MAXION 2.8D Y 3.0 POWER STROKE	Polea Ø67x38 L=44,3 mm	(ERR 1972 A) INA 140564.1 VKM 17405H
1467		POLY V AUTOTENSOR de ACCESORIOS MOTOR MAXION 2.5 TDI / FORD F-100 / Ranger 97' 2.5 D/TD HS-Maxion	Ø85 x 32 x Ø17 L=100 mm	T 38425 534011720 (ERR 4708) VKM 37420 VKM 04781 F 236649









Artículo Article		Modelos que reemplazan Models that they replace	Dimensiones Dimensions	Equivalencias Equivalences
1467 P		Polea sola de autotensor de ACCESORIOS MOTOR MAXION 2.5 TDI FORD F-100 / Ranger 97 2.5 D/ TD HS-Maxion / 2.8 D / 3.0 D Power Stroke 01/..	Ø85 x 32 x Ø17	Polea sola (ERR 4708) VKM 37420 VKM 04781
1468		ECOSPORT 1.4 TDCI FIESTA 1.4 TDCI	Ø60 x 30 x 10	532032110 VKM 23140 VKM 23140 F123906
1469		RANGER 3.0 TDI Maxion	Ø90 x 29 mm	OEM 70810066 VKM 04776 F-565352
1469 P		Ford Ranger Motor 3.0 D 06/12 Polea de repuesto tensor	Ø90 x 29 x Ø17	Polea sola reparación VKM 04776 P F-565352
1470		Courrier Pick Up 1.6 Rocam; Fiesta y Focus 1.6 8v. Zetec Rocam; Ka 1.0 Rocam; Ka 1.6 Rocam	Ø70 X Ø8 X 24 L=35.5mm	VKM 04786
1472		Polea Fija DE ACCESORIOS F100 4 CIL. TURBO MOTOR MWM	Polea Ø80x32	(MWM38001 BF8T-19A216-AA) INA F123142 VKM 26501
1484		Ford Ranger 2.5 HSD Maxion T	Ø85 x 23	T36130 VKM 34299 H VKM 60005 F48818.2
1524		Mondeo 2.0 TDCI	Ø60 x 30 L=41mm	T 42199 INA 124178 VKM 23257
1531		Ford Fiesta 1.4 - Ecosport Focus II 1.6 TDCI	Ø60 x 30 x Ø10 L=46 mm	F-122285.6 VKM 33044 GATES T36034 INA 532032010 F-123934.50



Artículo Article		Modelos que reemplazan Models that they replace	Dimensiones Dimensions	Equivalencias Equivalences
1533		DISTRIBUCIÓN Autotensor ECO SPORT 1.4 TDCI FIESTA 1.4 TDCI / 1.4 16v	Ø60 x 30 L=39	VKM 13140 T43158 531055510 F-232828.08
1539		DISTRIBUCIÓN Polea de inversión / guía ECO SPORT KINETIC 1.5 L TDCI (2013-2015)	Ø61 x Ø10 x 31	VKM 23121 T42307 532062410
1577		POLY V ALTERNADOR FORD Ranger 2.5 MPI Ford 2.5 Mondeo III y IV 2.5T; Kuga 2.5 V6	Ø53 X 27 L=35.5mm	INA: F-124274 VKM 26602 T42097 531009110
1593		POLY V tensor Automático FORD GALAXY 1.8 - 2.0 L	Ø90 x 31 L=78	
1593 P		POLY V Polea sola GALAXY 1.8 - 2.0 L	Ø76 x Ø17 x 31	VKM 048234 APV 2900
1610		POLY V Ranger 2.5 Nafta SOHC Ranger 4 cil. Transit 1.5 TDI	Ø76x25xØ17	INA: F550491 VKM: 31039
1620		DISTRIBUCIÓN CONJUNTO MAXION MOTOR MAXION HS 2.5 MOTOR MAXION 2.8 POWER STROKE (Contiene tensor fijo 1465; móvil 1466 y rueda dentada 1621) HS 500		VKMA 074051 AC C/engranaje cigüeñal
1621		DISTRIBUCIÓN Engranaje Fijo F 100, RANGER MOTOR MAXION HS 2.5D, 2.8D Y 3.0 POWER STROKE (CIGUEÑAL)	Ø71.5 x Ø31.8 L=47.3 mm	VKM 174104 ERR 100660
1632		POLY V Autotensor Ford Cargo 814, 815, 915 motor Cummins 6CT, Ford F100.	Polea Ø74 x 39 L=50mm	OEM 3914086 T 38504 VKM 910015 Dayco 89409 3922900









Artículo <i>Article</i>	Modelos que reemplazan <i>Models that they replace</i>	Dimensiones <i>Dimensions</i>	Equivalencias <i>Equivalences</i>
<p>1632 P</p> 	<p>Polea sola de Autotensor Ford Cargo 814, 815, 915 motor Cummins 6CT, Ford F100.</p>	<p>Polea Ø74 x 39</p>	<p>Polea Sola VKM 910015 Dayco 89409</p>
<p>1633</p> 	<p>Autotensor Ford Cargo 814, 815, 915 motor Cummins 6BT Polea acanalada</p>	<p>Polea Ø71.5 x 35 L=51mm</p>	<p>VKM 910011 Dayco 89415 3936250</p>
<p>1633 P</p> 	<p>Polea sola de Autotensor Ford Cargo 814, 815, 915 motor Cummins 6BT Polea acanalada</p>	<p>Polea Ø71.5 x 35</p>	<p>Polea sola VKM 910011 Dayco 89415</p>
<p>1642</p> 	<p>Ford Courier, Ka, Fiesta Motor Rotocam Zetec 1.0 y 1.6 Rocam</p>	<p>Ø69,5 x 26 x Ø17</p>	<p>VKM 04793</p>
<p>1643 P</p> 	<p>Polea Recambio RANGER (2012) 2.2 MOTOR PUMA RANGER 3.2 DSL</p>	<p>Ø65 x Ø17 x 30</p>	<p>Polea Recambio APV 4076 534068210</p>









Artículo Article		Modelos que reemplazan Models that they replace	Dimensiones Dimensions	Equivalencias Equivalences
1437		JEEP RENEGADE 2.0 JTD	Ø65 x 30	VKM 12174 1987949804 947478 T-43211 T-43042 F-232477 531025530 531084410
1542		Tensor Móvil JEEP Cherokee 2.1 D J8S	Polea Ø60x35 L=47 mm	F-37630.1 VKM 16210
1543		Polea Fija JEEP Cherokee 2.1 D J8S	Polea Ø60x33 L=45 mm	Polea Recambio INA F37734.2 VKM 26211
1561		JEEP CHEROKEE2.1 ITD (185-814) 84/95I	Ø63x33 L=45,2	531025010 VKM 16212 T 41163 F-123149
1610		Terracan 1.9 CRDI	Ø76x25xØ17	INA F550491 VKM 31039









Artículo Article		Modelos que reemplazan Models that they replace	Dimensiones Dimensions	Equivalencias Equivalences
1631		Tensor móvil Isuzu 2.8D/3.1D	Ø67 x 38 Largo total 43 mm	INA 531015020 VKM 79002 T 41196
1634		Pick Up 2.5D-TD / 2.8TD / 3.1 TD Trooper 3.1TD Frontera 2.7D 4x4	Ø67 x 38.5 L=41 mm	INA 532007620 VKM 89003

Artículo Article		Modelos que reemplazan Models that they replace	Dimensiones Dimensions	Equivalencias Equivalences
1465		DISTRIBUCIÓN Polea Fija MERCEDES BENZ SPRINTER, ROVER LHV-100150 MOTOR MAXION HS 2.5 D/TD desde 11/97'	Polea Ø64.5x35 L=43 mm	(ETC 8560 A) F-140070.1 VKM 27405H
1466		DISTRIBUCIÓN Tensor Móvil MERCEDES BENZ SPRINTER, ROVER LHP-100680 MOTOR MAXION HS 2.5 D/TD desde 11/97'	Polea Ø67x38 L=44.3 mm	(ERR 1972 A) INA 140564.1 VKM 17405H
1467		POLY V AUTOTENSOR de ACCESORIOS MOTOR MAXION 2.5 TDI MERCEDES BENZ Sprinter 2.5 D/TD HS-Maxion / Rover	Ø85 x 32 L=100 mm	(ERR 4708) APV 1004 VKM 37420 04781
1467 P		POLY V Polea recambio tensor de ACCESORIOS MOTOR MAXION 2.5 TDI MERCEDES BENZ Sprinter 2.5 D/TD HS-Maxion / Rover	Ø85 x 32 x Ø17	APV: 1004 (ERR 4708) VKM: 37420 04781 Polea recambio
1484		POLY V LAND ROVER DISCOVERY - DEFEDER 2.5 TDI MERCEDES BENZ SPRINTER 310-311 D CON A/AC MOTOR MAXION	Ø85 x 23	T36130 VKM 34299 H VKM 60005 F-48818.2
1493		DISTRIBUCIÓN Tensor Fijo ROVER Serie 200 / 400 Motor: 1.8 D / 1.9 D 8A8 (XUD7T)	Polea Ø60x35 L=45.5 mm	(LHP 100070) INA F122980 VKM 23241
1498		DISTRIBUCIÓN Tensor MOVIL ROVER Serie 200 / 400 Motor: 1.8 D / 1.9 D 8A8 (XUD7T)	Polea Ø60x35 L=45.5 mm	(LHP 10 010) INA F122216.3 VKM 13241
1558		POLY V Polea de ACCESORIOS MERCEDES BENZ Clase A 140/160 1.4 / 1.6	Ø69.5 x 23 x Ø17	Polea recuperación (A166202061) VKM 01016 032145299A
1620		DISTRIBUCIÓN CONJUNTO MAXION MOTOR MAXION HS 2.5 MOTOR MAXION 2.8 POWER STROKE (Contiene tensor fijo 1465; móvil 1466 y rueda dentada 1621) HS 500		VKMA 07405 AC con engranaje cigüeñal

Artículo <i>Article</i>	Modelos que reemplazan <i>Models that they replace</i>	Dimensiones <i>Dimensions</i>	Equivalencias <i>Equivalences</i>
<p>1621</p> 	<p style="writing-mode: vertical-rl; transform: rotate(180deg);">DISTRIBUCIÓN</p> <p>Engranaje Fijo MERCEDES BENZ SPRINTER MOTOR MAXION HS 2.5D, 2.8D Y 3.0 POWER STROKE</p>	<p>Ø71.5 x 47.3</p>	<p>ERR 100660</p>
<p>1638</p> 	<p style="writing-mode: vertical-rl; transform: rotate(180deg);">DISTRIBUCIÓN</p> <p>Mercedes Benz 1114, 1215, 1517, 1620 Tensor del compresor</p>	<p>Ø52 x 30 x Ø10 L=32</p>	<p>VKM 04897 564583F51</p>

Artículo Article		Modelos que reemplazan Models that they replace	Dimensiones Dimensions	Equivalencias Equivalences
1409		DISTRIBUCIÓN Tensor móvil EXPERT 1.6	Ø56 x 24 x Ø30	(5972277 0818.21) INA F36261 VKM 12200
1420		DISTRIBUCIÓN TENSOR MOVIL BOXER 2.8D – 2.5D	Ø67 x 34 x Ø25	(0830.40) INA F113338 VKM 12380
1421		DISTRIBUCIÓN TENSOR FIJO BOXER 2.8D – 2.5D	Ø64.5 x 34 x Ø25	(4740847 0830.32) INA F113339 VKM 22380
1468		DISTRIBUCIÓN 307 SW 1.6 HDI 16V 207 1.4 HDI EXPERT (08); 308; 408 1.6 HDI	Ø60 x 30 x Ø10	INA 532032110 VKM 23140 F-123906
1491		POLY V Tensor Móvil 306, 405, 406, 605 1.8 D XUD7 / 1.9 D/TD XUD9AU/TE/TSU BOXER, EXPERT, PARTNER MOTORES XUD 1.8D-1.9D-2.1D 806 / XM Motor: 1.9 D XUD9TE / 2.1 TD XUD11BTE	Polea Ø85x26 L=34.25 mm	(9607451480 5751.38) INA: F123000 VKM: 33002
1492		POLY V Tensor Móvil de ACCESORIOS 306,405 D. Partner Motor: 1.8 D XUD7 / 1.9 D/TD XUD9A/TE	Polea Ø60x28 L=107 mm	(96199932 5751.23) INA 123736 VKM 33040
1493		DISTRIBUCIÓN Tensor Fijo 205, 306, 405, 406, 605, 806, EXPERT, PARTNER desde 01/'94, BOXER MOTORES 1.8 D XUD7/T / 1.9 D / TD XUD9/T / XUD9TE	Polea Ø60x35 L=45.5 mm	(9615923380 0830.13) INA F122980 VKM 23241
1494		DISTRIBUCIÓN Tensor Fijo 205, 306, 405, 406, 605, 806, EXPERT, PARTNER hasta 01/'94 MOTORES XUD 1.8D-1.9D	Polea Ø60x35 L=45.5 mm	(9350110580 0830.02) INA F123369 VKM 23240
1495		POLY V Tensor Móvil de ACCESORIOS 205 1.6-1.9, 205 1.8D-1.9D, 405 1.4-1.6-1.9, 405 1.8D-1.9D	Polea Ø85x22 L=38.5 mm	(6453.76) INA F38931.4 VKM 33010

Artículo Article		Modelos que reemplazan Models that they replace	Dimensiones Dimensions	Equivalencias Equivalences
1497		DISTRIBUCIÓN Tensor Móvil 205, 306, 405, 406, 605, 806, EXPERT, PARTNER hasta 01/'94 MOTORES XUD 1.8D-1.9D, 1.6-1.9	Polea Ø60x35 L=45.5 mm	(0829.11) INA: F122051 VKM 13240
1498		DISTRIBUCIÓN Tensor MOVIL 205, 306, 405, 406, 605, 806, EXPERT, PARTNER desde 01/'94 MOTORES XUD7 1.8D-1.9D TD XUD9/T / XUD9TE	Polea Ø60x35 L=45.5 mm	(0829.33) F-122216.3 VKM 13241
1499		POLY V Polea de Alternador para correa trapezoidal 504, 505 DIESEL, 504 PICK UP MOTORES 2.3D XD2, XD3 (Conjunto armado Eje y Polea)	Polea Ø77x14 L=18.5 mm	(5751.40)
1500		POLY V Polea de Dirección Hidráulica para correa trapezoidal 504, 505 504 PICK UP EJE 14 mm MOTORES XD2, XD3 (Conjunto armado Eje y Polea)	Polea Ø77x14.5 L=24 mm	(1281130)
1501		POLY V Tensor Fijo c/ Soporte Fundición de accesorios 306, 405, 406, 605, 806, BOXER, EXPERT, PARTNER MOTORES XUD7 1.8D - 1.9 D XUD9TE 2.1 TD XUD11BTE	Polea Ø60x28 L=46 mm	(96501545 5751.24) INA F122544 VKM 33008
1502		POLY V POLEA Fija recambio tensor de accesorios 306, 405, 406, 605, 806, BOXER, EXPERT, PARTNER MOTORES XUD7 1.8D - 1.9 D XUD9TE - 2.1 TD XUD11BTE	Polea Ø60x28	Polea recambio (96501545 5751.24) INA F122544 VKM 33008
1503		POLY V Polea Fija de ACCESORIOS 205 405 1.8D-1.9D (NYLON)	Ø70 x 25.5 Rosca M12x1.25 L=28 mm	(5751.14) INA F121373.1 VKM 33006
1504		POLY V Polea 306 / 405 / 605 / 806 Motor 1.6 / 1.8 / 2.0 / 1.9 D/TD / 2.0 16v NYLON	Ø90 x 25 x Ø17	(5751.20) F-224669 VKM 33034 03011
1505		DISTRIBUCIÓN Tensor Móvil 505 2.0, 2.2	Polea Ø60x30 L=42 mm	(7700692315) INA F120726 VKM 16200



Artículo Article		Modelos que reemplazan Models that they replace	Dimensiones Dimensions	Equivalencias Equivalences
1506		DISTRIBUCIÓN Tensor Excéntrico Móvil 306 - 405 1.9 16V-2.0 16V MOTOR XU9J4, XU10J4TE	Polea Ø56x31 L=41.3 mm	(0829.20) INA F120046.4 VKM 13210
1507		POLY V Tensor Móvil DE DIREC. ASISTIDA BOXER 2.5D MOTOR DJ5/DJ5T/DJ5TED	Polea Ø94x26 L=32.5 mm	(96155001 4007 E4) INA F121977.1 VKM 33015
1508		POLY V Tensor Excéntrico Móvil de ACCESORIOS 206 / 306 / 406 / 605 / 607 / 806 807/ Expert / Partner MOTOR 1.8 D XUD7 / 1.9 D / TD XUD9 / XUD9TE / DW8 / 2.0 Hd DW10 TD/ATED / 2.1 TD XUD11BT	Polea Ø69.5x27 L=28.75 mm	(9618888580 5751.29) INA F122662 VKM 33013
1509		POLY V AUTOTENSOR Móvil de ACCESORIOS 206, 306, 405, 406, 605,806 PARTNER, EXPERT Motor 1.9 D DW8 / DW8B / 2.1 TD XUD11BTE (DIESEL)	Polea Ø60x27 L=92.5 mm	(5751.30) INA F123787 VKM 33029
1509 P		POLY V Polea recambio tensor de ACCESORIOS 206, 306, 405, 406,605,806 PARTNER, EXPERT MOTORES 1.9 D DW8 / DW8B / 2.1 TD XUD11BTE (DIESEL)	Ø60 x Ø8 x 27	Polea recambio INA F123787 VKM 33029
1510		DISTRIBUCIÓN Tensor Excéntrico Móvil 106, 205, 306, 307, 405, 406, 605, 506, 806, EXPERT, PARTNER 1.1 TU1JP / 1.4i TU3JP / 1.6 TU5JP / 1.8 XU7JP / 2.0 XUJ2C	Polea Ø60x22 L=32.7 mm	9605266280 0829.19) INA F121287.5 VKM 13100
1511		POLY V Tensor Móvil de ACCESORIOS 206, 306, EXPERT, PARTNER 98/05 MOTOR DW8 / DW8B 1.9D	Polea Ø85x26 L=34.25 mm	INA F123305.1 VKM 33004
1512		DISTRIBUCIÓN Tensor Excéntrico Móvil 206 / 306 / 307 / 406 / 607 / 806 / 807 / Boxer / Expert / Partner 99/.. Motor: 2.0 Hd DW10TD / DW10ATED/ ATED4 / 2.2 Hd DW12TED4	Ø 60 X 34 L=40.9 mm	(0829.62) INA F122985.51 VKM 13246
1513		POLY V Tensor para correa Poly - V 206 TURBO DIESEL 1.9 D - 405 - 306 PARTNER - EXPERT 1.9 D DW8 51 KW	Ø38 X Ø10 x 27 L=28	INA F123880.2 VKM 33017









Artículo Article		Modelos que reemplazan Models that they replace	Dimensiones Dimensions	Equivalencias Equivalences
1514		DISTRIBUCIÓN Polea Fija 206 / 306 / 307 / 406 / 607 / 806 / 807 / Boxer / Expert / Partner 99/.. Motor: 2.0 HDi DW10TD / DW10ATED/ATED4 / 2.2 HDi DW12TED4 (NYLON)	∅ 60 X ∅ 10 X 34 L=40mm	F-122986.5 F122124.2 VKM 23246
1515		DISTRIBUCIÓN Tensor Peugeot 306, 206 Partner motor 1.9D y 2.0 TD, 307 406 607 motor 2.0 HDI	Polea ∅60x30 L=40 mm	INA F122985.51 VKM 13244
1516		DISTRIBUCIÓN Tensor Peugeot 306 605 406 806 motor 2.0 16v. 406 motor 1.8 16v	Polea ∅56x29 L=40 mm	INA F122868 VKM 13202
1517		DISTRIBUCIÓN Polea Nylon 206 2.0 RC EW10J4S '03/'04 206 2.0 16V EW10J4 '99/'04 307 2.0 16V EW10A '06/= > 407 2.016V EW10J4 '07/= >	Polea ∅60x30x∅10 L=37mm	(9660098680) (0830.42) VKM 23230
1518		DISTRIBUCIÓN Polea Nylon Peugeot 206 1.6 16V TU5JP4 '00/'06 307 1.6 16V TU5JP4 '00/= >	Polea ∅60 x 30 x ∅8 L=39.25mm	INA F122374 VKM 23256
1519		POLY V Polea Nylon de Accesorios 206 - Expert - Berlingo 1.9 D DW8	∅60 x ∅10 x 25 L=28 mm	INA F236667 VKM 33031
1519 P		POLY V PEUGEOT 206 1.9D / 206 1.4 02/09 C A/A / 206 1.6 16v / 207 y 306 1.9 DW8	∅60 x 25	Polea recambio VKM 33031 VKM 33032 VKM 33101 VKM 36020
1520		DISTRIBUCIÓN Polea Fija 306 - 406 2.0 16v XU10J4R - RS	∅60 x ∅10 x 28.5 L=39 mm	IINA F122124.51 VKM 23213
1521		DISTRIBUCIÓN TENSOR 206 2.0 RC / 2.0 16v 307 - 407 2.0 16v EW10J4 / EW10J4S 406 2.0 16v EW10J4 / 406 - 407 2.2 16v / 807 2.0 16v EW10J4/2.2 16v EW12J4	Polea ∅ 62 x 30 L=37.5	INA F125081 VKM 13234









Artículo Article		Modelos que reemplazan Models that they replace	Dimensiones Dimensions	Equivalencias Equivalences
1522		DISTRIBUCIÓN Tensor 106 1.6 16 V.- 206, 307 y Partner 1.6 16V hasta motor N°1806404 Polea Maciza	Ø56 X Ø8 x 32 L=40mm	(0830.20 - 0830.61) INA F122574 VKM 23130
1523		POLY V 206 2.0 HDI DW10TD sin aire a. 306 y 307 2.0 HDI con aire acond. EXPERT 2.0 HDI sin aire acond., PARTNER 2.0 HDI sin aire acond.	Ø50 X Ø8 X 26 con dos hileras de bolillas	INA 532014310 F-122530 VKM 33069 T 36151
1524		DISTRIBUCIÓN 307 y 807 2.0 HDI 136HP EXPERT 2.0 HDI	Ø60 x Ø10 X 30 L=41mm	INA 124178 VKM 23257
1525		POLY V 206 1.9D Y 2.0HDI, 207 1.9D Y 2.0HDI, 306 1.9D 1.9TD 1.9TDI 2.0HDI, 307 2.0 HDI, 405 1.9 SRD, 406 1.9 TD 2.0HDI, 407 806 Y 807 2.0HDI	Ø70 x Ø 10 x 25.5 L=27mm.	INA F571057 VKM 33045
1526		DISTRIBUCIÓN 206; 307 y Partner 1.6 16V.	Ø73 x 31 L=41 mm	INA F232829.4 VKM 13132
1527		DISTRIBUCIÓN 106 1.5D	Ø59 x 28.5 L=39 mm	INA F120447 VKM 13120
1528		POLY V 206 1.4; 206 1.6 y 16V Partner 1.6	Ø70 x Ø10 x 27 L=29mm	INA F-122332 VKM 33023
1529		POLY V PEUGEOT 206 / 207	Ø65 x 26 x Ø17	VKM 31303 GATES T36376 INA532055710 F-561582.04 F-576987 F-237268.04 F-553814.03
1529 P		POLY V PEUGEOT 206 / 207	Ø65 x 26 x Ø17	VKM 31303 GATES T36376 INA532055710 F-561582.04 F-576987 F-237268.04 F-553814.03









Artículo Article		Modelos que reemplazan Models that they replace	Dimensiones Dimensions	Equivalencias Equivalences
1530		DISTRIBUCIÓN PEUGEOT PARTNER II	Ø 60 x 30 x Ø10	VKM 33131 GATES T36295 INA 532053810 F-123934.17
1531		DISTRIBUCIÓN PEUGEOT 206 / 207 1.4 - 1.6 HDI	Ø 60 x 30 x Ø10	F-122285.6 F-123934 VKM 33044 GATES T36034 INA 532032010
1532		DISTRIBUCIÓN PEUGEOT 206 / PARTNER 1.4 - 1.6 16v	Ø60 x 30 x Ø10	VKM 33100 GATES T36190 INA 532033110 F-124197.51
1533		DISTRIBUCIÓN PEUGEOT 206 1.4 DIESEL / 207 / EXPERT / PARTNER 1.6 HDI DIESEL	Ø60 x 29	Bosch 1987949864 T43158 - T38408 F-232828.08 531055510 531042710 VKM 13140
1534		DISTRIBUCIÓN PEUGEOT 206 / 207 / PARTNER 1.4 NAFTA	Ø60 x 26	Bosch 987949893 T43023 - T43062 F-125042 531057210 VKM 13253
1535		POLY V PEUGEOT 206 1.9 D	Ø60 x 26 x Ø17	VKM 33032 GATES T38236 INA 531042210 F-236668
1535 P		POLY V Polea recambio PEUGEOT 206 1.9	Ø60 x 25	Polea recambio: VKM 33032 T-38236 531042210
1536		DISTRIBUCIÓN PEUGEOT 307 / 407 / 408 / 807 / 308 2.0 16v	Ø62 x 29	T 43145 VKM 13263 531077010
1537		DISTRIBUCIÓN PEUGEOT 206 / 307 / 406 EXPERT / PARTNER 2.0 HDI	Ø70 x 25	T38156 - T38392 F-236666 534011020 VKM 33033









Artículo Article		Modelos que reemplazan Models that they replace	Dimensiones Dimensions	Equivalencias Equivalences
1537 P		DISTRIBUCIÓN PEUGEOT PARTNER PATAGONICA EXPERT / 806 / 406 Familiar / 307 / 807 / 306 4P-5P-SW / 206 / 207 COMPACT 2.0 HDI	Ø70 x 25,5	Polea sola para: VKM 33033 T38392 F-236666 534011020
1538		POLY V PEUGEOT 206 / 207 / PARTNER 1.4 / 1.6 16v	Ø60 x 26	VKM 33101 T39055 534017910
1539		DISTRIBUCIÓN PEUGEOT 308 / 408 / EXPERT / 301 1.6 / 3008 2.0	Ø61 x 30	VKM 23121 T42307
1540		DISTRIBUCIÓN Polea inversion guia PEUGEOT 406 (8B) 3.0 24V, 406 Break (8E / F) 3.0 24V, 607 (9D, 9U) 3.0 V6 24V, 607 (9D, 9U) 3.0 V6 24V	Ø65 x Ø8 x 26,5	VKM 33075 531063110 T 36451
1565		DISTRIBUCIÓN Polea recambio PEUGEOT 206, 306 PARTNER 1.9 DW8	Ø61 x Ø17 x 26	VKM 36031 T36176 APV 2159 F-124059 532024310
1571		POLY V POLEA FIJA ALTERNADOR BOXER 2.8 HDI SOFIM 2800	Ø60XØ8.4X26	INA 532036720 VKM 36017 F-562368.1 T36076
1581 P		DISTRIBUCIÓN Polea recambio PEUGEOT 207 1.4 8v 207, 307, 308 1.6 16v 206 GTI / RC 2.0 16v 307 2.0 16v	Ø65 x Ø17 x 26	Polea recambio
1642		DISTRIBUCIÓN PEUGEOT 308 1.6	Ø69,5 x 21,8 6 canales	VKM 04793
1644		POLY V Autotensor distribucion PEUGEOT 206 - 207 - 208 - 301 - 307 - 308 - 407 Motor 1,6 Vti - 1,6 16V	Ø70 x 30	VKM13256 F-232829.5 531063210 GATES T43159









Artículo <i>Article</i>	Modelos que reemplazan <i>Models that they replace</i>	Dimensiones <i>Dimensions</i>	Equivalencias <i>Equivalences</i>
1646 	DISTRIBUCIÓN Tensor automatico poly V PEUGEOT 307 - Partner - Hoggar 1,6 16V	$\varnothing 60 \times 25$	VKM 33036 APV 2556 534044710 T39126
1652 	DISTRIBUCIÓN Polea recambio tensor Peugeot 206 1.1 / 1.4 / 1.6 s/AA - Partner patagonia 1.6 Nafta 207 1.4 - 1.6 - 2.0 8v TUS y TUSJP	$\varnothing 70 \times \varnothing 10 \times 28$	VKM33018-1 F-122748.11 531030610 T38232
1801 	DISTRIBUCIÓN PEUGEOT 206 / 306 / 607 / PARTNER 1.9 DIESEL		T38407 F123788 F124058 53300110 VKM 33311

Artículo Article		Modelos que reemplazan Models that they replace	Dimensiones Dimensions	Equivalencias Equivalences
1416		POLY V TENSOR POLY V CLIO 1.4 ENERGY E7J C/A.A.	Ø68 x Ø17 x 22	(7700854373) VKM 36002 APV 2763 T36041
1420		DISTRIBUCIÓN TENSOR MOVIL MASTER, TRAFIC S8U-8140 2.8D TRAFIC 2.5 D motor S8U MASTER 2.5D S8U/748 Sofin S9U y 2.8 TDi S9W	Ø67 x 34 x Ø25	(5001001259 7701040204) INA F113338 VKM 12380
1421		DISTRIBUCIÓN TENSOR FIJO MASTER, TRAFIC S8U-8140 2.8D TRAFIC 2.5 D motor S8U MASTER 2.5D S8U/748 Sofin	Ø64.5 x 34 x Ø25	(5001001272) INA F113339 VKM 22380 531055710 T41234
1453		POLY V Polea Fija DE ACCESORIOS CLIO II 1.9D	Ø69.5 x 26 x Ø17	Polea recambio (7702217980) INA F235783 VKM 34034 VKM 60001
1472		DISTRIBUCIÓN Polea Fija LAGUNA 1.8 / 2.0 Motor 2.2 D	Polea Ø80xØ10x32	(7700862615) INA F123142 VKM 26501
1519		DISTRIBUCIÓN Tensor Renault CLIO II 1.6 K7M 746 C/AA CLIO II 1.6 16v K4M C/AA	Ø60 x 25 x Ø10 L=28	VKM 33301 VKM 33032 VKM 33101 VKM 36020
1519 P		DISTRIBUCIÓN Polea recambio CLIO II 1.6 K7M 746 C/AA CLIO II 1.6 16v K4M C/AA	Ø60 x 25 x Ø17	Polea recambio VKM 33301 VKM 33032 VKM 33101 VKM 36020
1529		DISTRIBUCIÓN Polea fija de accesorios RENAULT FLUENCE 1.6 16v KANGOO / SANDERO 1.5 DCI	Ø65 x 26 x Ø10	VKM 31303 T36376 INA 532055710 F553814.03
1529 P		DISTRIBUCIÓN Polea recambio RENAULT FLUENCE 1.6 16v RENAULT CLIO / DUSTER KANGOO / SANDERO 1.5 DCI	Ø65 x 26 x Ø17	VKM 31303 T36376 INA 532055710 F553814.03

Artículo Article		Modelos que reemplazan Models that they replace	Dimensiones Dimensions	Equivalencias Equivalences
1541		DISTRIBUCIÓN Tensor Móvil CUPE FUEGO, R18, R21, TRAFIC, MASTER MOTORES J5R, J7R, J7T 1.6, 2.0 y 2.2	Polea Ø60x30 L=41 mm	(7700692315) INA F37629 F120726 VKM 16200
1542		DISTRIBUCIÓN Tensor Móvil R18, R21, TRAFIC, MASTER MOTORES J8S 2.1D, F8Q 1.9D	Polea Ø60x35 L=47 mm	(7700722452) F-37630.1 VKM 16210
1543		DISTRIBUCIÓN Polea recambio R18, R21, TRAFIC, MASTER MOTORES J8S 2.1D, F8Q 1.9D	Polea Ø60x33 L=45.5 mm	(7700721690) INA F37734.2 VKM 26211
1544		DISTRIBUCIÓN Tensor Móvil R9, R11, R19, R21, CLIO, CLIO II, TWINGO, LAGUNA, MEGANE, EXPRESS, KANGOO, TRAFIC 1.7 / 1.8 (F2N / F3P) / 1.9 D / 1.9 dTi (F8Q / F9Q) / 2.0 (F3R)	Polea Ø50x31 L=36 mm	(7700726440) INA F123776 VKM 16101
1545		DISTRIBUCIÓN Tensor R9, R11, R19, R21, CLIO, CLIO II, TWINGO, LAGUNA, MEGANE, SCENIC, EXPRESS, KANGOO, TRAFIC 1.7 / 1.8 (F2N / F3P) / 1.9 D / 1.9 dTi (F8Q / F9Q) / 2.0 (F3R)	Polea Ø50x31 L=42.5 mm	(7700735486 7700863112) INA F123474 VKM 26101
1546		POLY V Tensor Móvil DE ACCESORIOS MEGANE / Scenic / Coupe / Cabriolet MOTOR K7M 1.6 NYLON	Polea Ø70x25.5 L=47 mm	(7700272972) INA F122481.6 VKM 36005
1547		POLY V Polea Fija DE ACCESORIOS R9, R11, R19 CHAMADE, R21, CLIO 1.7 / 1.8 F2N / F3P (CHAPA)	Ø70 x 30 x Ø10.2	(7700850603) INA F120850 VKM 36013
1548		POLY V Polea Fija DE ACCESORIOS R9, R11, R19 CHAMADE, R21, CLIO 1.7 / 1.8 F2N / F3P (NYLON)	Ø70 x 30 x Ø10	(7700850603) INA F120850 VKM 36013
1549		POLY V Tensor Móvil DE ACCESORIOS R9, R11, R19 1.9D, CLIO, MEGANE 1.9D, EXPRESS 1.9 D c/A.A. SIN SOPORTE	Polea Ø90x26 L=32.9 mm con Engranaje	Polea reparación (7700852410) INA F121271.1 VKM 36012







Artículo Article		Modelos que reemplazan Models that they replace	Dimensiones Dimensions	Equivalencias Equivalences
1550		POLY V Tensor DE ACCESORIOS R19 1.9D, CLIO 1.9D, EXPRESS 1.9 D c/A.A.	Polea Ø50x28 L=48.25 mm	(7700271618) INA F121586 VKM 36014
1551		DISTRIBUCIÓN Tensor Fijo R19, CLIO, CLIO II, MEGANE, EXPRESS, KANGOO 1.8 16v/ 2.0 16v/ 1.9 D, SCENIC 2.0 16 Val.	Polea Ø50x31 L=42.5 mm	(7700733489) INA F123475 VKM 26102 F 122384
1552		DISTRIBUCIÓN Tensor FIJO CLIO, KANGOO, LAGUNA, TWINGO, MEGANE, SCENIC MOTOR F9Q 1.9D	Polea Ø64.5x31 L=42 mm	(7700100671) INA F123779 VKM 26115 F 123089.2
1553		POLY V Tensor DE ACCESORIOS (MOVIL) R19, CLIO, CLIO II, MEGANE, LAGUNA MOTORES 1.8, 2.0, SCENIC 2.0	Polea Ø69.5x28 L=34.9 mm con Engranaje	(7700851321) INA F121366 VKM 36006
1554		DISTRIBUCIÓN Engranaje Fijo CLIO, CLIO II, EXPRESS, KANGOO, MEGANE, TRAFIC, LAGUNA MOTORES F8Q y F9Q 1.9D	Ø59.3x31 L=32 mm	(7700875307) (7700107249) INA F123777 VKM 26125 F 123035
1555		DISTRIBUCIÓN Engranaje Fijo LAGUNA, MEGANE, SCENIC MOTORES F3P y F3R 1.8-2.0	Ø59.3x25.5 L=26.5 mm	(7700875305) INA F123732 VKM 26123
1556		POLY V Polea Fija DE ACCESORIOS CLIO II, LAGUNA 1.9D, SCENIC, MEGANE 2.0 16V-1.9D	Polea Ø50x26	(7700867985) INA F122530.12 VKM 36016
1557		DISTRIBUCIÓN Tensor Excéntrico Móvil CLIO 1.2-1.4, CLIO II, R19 1.2-1.4, TWINGO 1.2, EXPRESS 1.4, MEGANE 1.4-1.6, KANGOO 1.2	Polea Ø50x22	(7700736085) INA F39924.10 VKM 16000 531005510 T41154
1558		POLY V Polea DE ACCESORIOS CLIO, CLIO II 1.9D, KANGOO 1.9D	Ø69.5 x 23.8 x Ø17	Polea reparación (A166202061) VKM 01016 032145299A





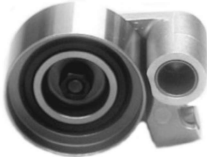



Artículo Article		Modelos que reemplazan Models that they replace	Dimensiones Dimensions	Equivalencias Equivalences
1559		DISTRIBUCIÓN Tensor Excéntrico Móvil CLIO, CLIO II, KANGOO, MEGANE MOTORES E7J 1.4, K7M 1.6	Polea Ø55x22	(7700273277) INA F123154 VKM 16001 VKM 16003H
1560		DISTRIBUCIÓN Tensor R19/ Clio Willians/ Megane Cabriolet/ Coupé Motor 1.8 16v (F7P) / 2.0 16v Willians (F7R)	Polea Ø50x31 L=36 mm	(77000736419) INA F120180 VKM 16112
1561		DISTRIBUCIÓN Tensor Móvil R18 D., R 21 D., ESPACE MASTER , TRAFIC D. MOTOR J8S LONG 2.1 D.	Polea Ø60x33 L=45.2 mm	(7700871169) INA F123149 VKM 16212
1562		POLY V Tensor Móvil MEGANE 1.6 CLIO II 1.4-1.6 16 v MOTORES K4J/K4M	Ø 70 X 25.5 dist. L=32mm	(7700105525) INA F123775 VKM 36091
1563		DISTRIBUCIÓN Tensor Automático CLIO, CLIO II, KANGOO, LAGUNA, MEGANE, SCENIC MOTOR 1.4 16V K4J710, 711, 712 Y 713 / MOTOR 1.6 16V K4M 708 Y K4M 748	Ø64 x 31 L=34.5 mm	(7700108117) INA F550228 VKM 16020
1564		DISTRIBUCIÓN Tensor Automático CLIO, CLIO II 1.9 DTI, KANGOO, LAGUNA, MASTER, MEGANE, SCENIC 1.9 dTi (F9Q)	Ø64 x 31 L=34.5 mm	(7700115862 8200079341) INA F238349 VKM 16551
1565		POLY V Polea KANGOO, CLIO II, MEGANE, LAGUNA, MASTER, KANGOO, SCENIC 1.4/ 1.4 16v/ 1.6/ 1.6 16v/ 1.8 16v/ 1.9 dCi (F9Q)/ 2.0 16v ALTERNADOR	Ø61 X 26 X Ø17	(7700102931) INA F124059 VKM 36031
1566		DISTRIBUCIÓN Polea Fija CLIO II, ESPACE III, KANGOO, LAGUNA, LAGUNA II, MEGANE I, MEGANE SCENIC, MEGANE SCENIC II, TRAFIC II, HALIA 1.4 16v / 1.6 16v CAPTURE, MEGANE, LAGUNA 2.0 16v	Ø70 X 25.5 dist. L=32mm	INA: F123778 VKM 26020 VKM 4597 F-123397
1567		DISTRIBUCIÓN Tensor Automático Clio II / Kangoo / Laguna / Megane / Scenic Motor 1.5 dCi (K9K)	Ø60xØ int.8.3x32 L=43mm	(8200102941) INA F125082 VKM 16102









Artículo Article		Modelos que reemplazan Models that they replace	Dimensiones Dimensions	Equivalencias Equivalences
1568		Polea fija accesorios Clio II 1.2 - 1.4 Twingo 1.2 16V Kangoo 1.2	Ø56xØ10.5x24 L=34.9 mm	(7700870795 7700868201) INA: F123148 VKM 36023 F 122573.7
1569		RENAULT CLIO II 1.2 16V D4F TWINGO 1.2 16V. D4F	Ø60 X 32 L=38.5mm	F 236389 531040410 VKM 4617 VKM 16002 T 43126
1570		Polea fija accesorios Clio II - Twingo 1.2 16V Kangoo 1.2	Ø56 X Ø8 X 21	(7700869666 8200040161) INA F122676 VKM 36025
1571		POLEA FIJA AIRE ACOND. MASTER II 2.8 dTi S9W 700 - 702	Ø60XØ8.4X26	(7701044676) INA:532036720 VKM 36017 F 562368.1
1572		POLEA FIJA AIRE ACOND. MASTER 2.8D / MASTER 2.5D S8U	Ø60XØ8.4X22	F 562369 (7701035966) INA 534012730 VKM 36001 53203920
1573		Tensor Clio II 1.9 DTI, Kangoo 1.9 DTI F9Q, Laguna 1.9 DTI F9Q 710 00/.. - F9Q 717, Megane 1.9 DTI F9Q 731-744, Scenic II 1.9 DTI F9Q 731-736-744 01/..	Ø64.5 x 31 L=42mm	(7700116054) INA F124284 VKM 26128
1574		Tensor Clio II 2.0 16V SPORT F4R, Laguna 1.8 16v F4P, Megane 2.0 16v F4R 740-741- 746-747 99/01 y 01/..	Ø54 x Ø17 x 33 Polea Nylon lisa	F 123781 VKM 26310 VKM 04611 INA 532030810 T 42167
1575		Tensor Clio II 2.0 16V SPORT F4R, Grand Scenic 2.0 16v F4R, Laguna II 2.0 16v F4R y Turbo / GT, Megane 2.0 16v F4R 740-741- 746-747 99/01, Megane II 2.0 16v F4R 770-771-774-776	Ø54 x Ø17 x 33 Polea Nylon acanalada	F 239960 VKM 26105 VKM 4599 INA 532044610 T 42166
1576		Clio; Scenic; Grand Scenic y Laguna 2.0 F4R Clio; Megane II; Scenic 2; Duster III 2.0 16V F4R Laguna 1.8 16v. F4P	Ø66 x 32 dist. L=34 mm	531041030 53106303 INA F237804 VKM 16550 T43035

Artículo Article		Modelos que reemplazan Models that they replace	Dimensiones Dimensions	Equivalencias Equivalences
1577		RENAULT Laguna 2.0	Ø53 x Ø8 x 27 L=35.5mm	532031710 531009110 INA F-124274 VKM 26602 532042310
1578		RENAULT CLIO II / KANGOO / LOGAN / MEGANE / SANDERO / SCENIC / SIMBOL 1.6 16v KANGOO / LOGAN / SANDERO SIMBOL 1.6 8v / LAGUNA 1.8 16v	Ø60 x 26 L=91mm	F 125039 T 38456 VKM 36020 534027110
1579		RENAULT MASTER 2.2 DCI / 2.5 DCI LAGUNA II 2.2 / DUSTER 2.0 16v	Ø60 x 31 x Ø17	VKM 36040 GATES T36084 INA 532036420
1580		RENAULT KANGOO / MEGANE / SCENIC 1.9 TDI	Ø60 x 26	VKM 36035 T38355 533004920
1581		PRENAULT CLIO / KANGOO / SIMBOL / MEGANE I / MEGANE II / SANDERO 1.5 DCI / DUSTER / OROCH / FLUENCE / SANDERO / SIMBOL 1.6 16v 2.0 DCI	Ø65 x 26 L=83 mm	1987948435 T39009 T 30159 VKM 36055 534026910
1581 P		Polea recambio RENAULT CLIO / KANGOO / SIMBOL / MEGANE I / MEGANE II / SANDERO 1.5 DCI / DUSTER / OROCH / FLUENCE / SANDERO / SIMBOL 1.6 16v 2.0 DCI	Ø65 x 26	Polea recambio: VKM 36055 T39009 - T30159 534026910 1987948435 Bosch
1643		Polea recambio renault TRANSIT 2,2 2010/2015 - Duster, Clío II, Megane II, Scenic 2.0 16v - Laguna, Megane II 1,9 Dci y 2.0 16v - Sandero (F4R)	Ø65 x Ø17 x 31	1731713 BK3Q6A228BD
1801		RENAULT LAGUNA / LAGUNA II 0.3	Ø31 x 130	T38407 F-123788 F-124058 VKM 33311









Artículo Article		Modelos que reemplazan Models that they replace	Dimensiones Dimensions	Equivalencias Equivalences
1453		Polea Fija de ACCESORIOS SUZUKI Fun Motor 1.0 (03/..)	Ø69.5 x 26 x Ø17	INA F235783 VKM 34034 VKM 60001 90500229 1340541
1455		Polea Fija de ACCESORIOS SUZUKI Fun Motor 1.0 (03/..) NYLON	Ø70 x 25.5 x Ø17	(7109163) VKM 33043 VKM 04839 534007520 T38331
1471		Tensor de ACCESORIOS SUZUKI Modelo: Fun Motor: 1.0 NYLON	Ø75 x Ø8 x 26 L=30.5 mm	INA F224134 VKM 35002
1512		Tensor Excéntrico Móvil Grand Vitara Motor 2.0 HDi DW10TD	Ø 60 X 34 L=40.9mm	INA F122985.51 VKM 13246
1514		Polea Fija Grand Vitara Motor 2.0 HDi DW10TD	Ø 60 X Ø 10 X 34 L=40.2	INA 122986.5 VKM 23246
1537		Autotensor Suzuki Grand Vitara 2.0 HDI	Ø70 x 25 L=67	VKM 33033 534011020 F-236666 T38237 APV1028
1537 P		Polea recambio Autotensor Suzuki Grand Vitara 2.0 HDI	Ø70 x 25	Polea recambio VKM 33033 534011020 F-236666 T38237 APV1028
1643		Polea recambio Suzuki Jimny	Ø65 x Ø17 x 31	1731713 BK3QGA228BD







Artículo Article		Modelos que reemplazan Models that they replace	Dimensiones Dimensions	Equivalencias Equivalences
1481		DISTRIBUCIÓN TENSOR MOVIL TOYOTA HILUX 2.4D, 2.8D Y SW4, LAND CRUISER 2.4D/2.8D/3.1D	Polea Ø62x35 L=46 mm	531019120 F-554841 (13546.54010) (13505-54021) VKM 71002 T 41181
1482		DISTRIBUCIÓN TENSOR FIJO TOYOTA HILUX 2.4D, 2.8D Y SW4 LAND CRUISER 2.4D/2.8D/3.1D	Ø83 x 35.5 x Ø12	532009820 (13503.54030) VKM 81002 T 42100
1485		POLY V POLEA DE CORREA DE ACCESORIOS MOVIL DODGE GRAND CHEROKEE, CHEROKEE, DAKOTA, CARAVAN MOTOR UM 2.5D (ITALIANO) '96-'99	Ø69.5 x 30 x Ø17	Polea reparación 4897159AB OEM
1487		DISTRIBUCIÓN TOYOTA 4 RUNNER 3.0 TD HILUX 2.5 D -4D 2KD-FTV HILUX 3.0 D 1KZ-TE	Ø62 X 29 L=35.5mm	531021520 VKM 71014 F-554653
1488		POLY V Polea loca fija accesorio Toyota HILUX 2005 en adelante 2.8 y 3.0	Polea Ø70x28.6 L=30.6 mm	VKM 610069 88440-0K010
1489		POLY V Polea loca fija accesorio TOYOTA HILUX 2005 en adelante 2.8 y 3.0	Polea Ø80x28.6 L=30.6 mm	
1490 P		POLY V Polea sola de TOYOTA HILUX 2005 en adelante 2.8 y 3.0	Ø75 x Ø17 x 32	VKM 61086 534036010 T39135 NSK EPBD-17-29 POLEA SOLA
1802		POLY V Amortiguador tensor TOYOTA HILUX 3.0 TDI HILUX Sw4 3.0 TDI LAND CRUISER	Ø25 x 92	VKM 71809 1987947489 T43226 533010810

Artículo Article		Modelos que reemplazan Models that they replace	Dimensiones Dimensions	Equivalencias Equivalences
1452		DISTRIBUCIÓN Tensor Móvil CADDY, CARAT, GACEL, GOL, GOLF, PASSAT, POINTER, POLO, QUANTUM, SAVEIRO, SENDA, SANTANA MOTOR AUDI AP 827 1.6-1.8-2.0	Polea Ø72x24 Distancia de Apoyo a Polea 28.5 mm	(026.109.243.E) INA F-217668 VKM 11000
1453		POLY V Polea Fija DE ACCESORIOS GOL 1.9 DIESEL/1.9SDI, SAVEIRO, CADDY	Ø69.5 x 26 x Ø17	(023.145.278.E) INA F-235783 VKM 34034 VKM 60001 Polea sola
1537 P		POLY V Polea recambio, tensor automático VW AMAROK 2.0 TDI TIGUAN 2.0 TDI FOX SURAM 1.9 TDI / POLO 1.9 SD	Ø70 x 25,5 x Ø17	Polea recambio VKM 31058 T38427 534016410 (Kuguell 1616)
1558		POLY V Polea de ACCESORIOS BORA 1.8 T, 1.9 TDI 90HP Y 110 HP C/AIRE / 100HP Y 115HP BORA 2.0/ GOLF 1.6 01/08 / GOLF V 1.6 07/... / GOLF IV 1.8T 99/07 / GOLF 1.9 TDI 99/07 / GOLF V 1.9 TDI 07/.. / GOLF V 2.0 99/07 / MULTIVAN 1.9 TDI / PASSAT (3C2) VARIANT (3C5) 2.0 / POLO CLASSIC 1.9 TDI 99/.. / SHARAN 1.8T Y 1.9 TDI / TRANSPORTER 1.9 TDI / VENTO 2.0 POLEA SOLA	Ø69.5 x 23.8 x Ø17	VKM 01016 REP. VKM 31011 / 31012 / 31018
1591		POLY V Polea de ACCESORIOS (FIJA) CADDY, GOLF, PASSAT, POLO, NEW SAVEIRO, SHARAN, TRANSPORTER MOTOR 1.6 (1F) / 1.9D/TD/TDI/SDI NYLON	Ø78 x 26 Rosca M8 x 1.25 L=27.2 mm	(028.145.278.E) INA F-214797.6 VKM 31004 531072980 T38087
1592		DISTRIBUCIÓN Tensor Excéntrico Móvil CADDY, GACEL, GOL, PASSAT, POLO, SAVEIRO, SENDA, GOLF, SANTANA MOTORES 1.6D y 1.9D	Polea Ø72x26 L=43	(068.109.243.F) INA F-220095 VKM 11010
1593		POLY V Tensor Automático de ACCESORIOS GOL (AB9), SAVEIRO, SENDA 1.6 DIESEL	Polea Ø76x31 L=78	(068.145.299R5)
1593 P		POLY V POLEA SOLA de Tensor Automático de ACCESORIOS GOL (AB9), SAVEIRO, SENDA 1.6 DIESEL (Pertenece al 1593)	Ø76 x 31 x Ø17	(068.145.299R5) VKM 04823 POLEA SOLA
1594		DISTRIBUCIÓN Polea Guía Fija CADDY, GOLF III, PASSAT, POLO, SHARAN MOTORES 1.7D y 1.9D/SDI/TDI	Ø29 x 29 x Ø8.3 L=31.5 mm	(028.109.244) INA F217278.1 VKM 21012 532012210

Artículo Article		Modelos que reemplazan Models that they replace	Dimensiones Dimensions	Equivalencias Equivalences
1595		POLY V POLEA DE ACCESORIOS POLO 1.6D, GOLF 1.6D, GOL SAVEIRO CADDY 1.9D/1.9SDI s/A.A. NYLON	Ø75 x 26 x Ø17	(028.145.299.1) VKM 04824
1596		POLY V AUTOTENSOR DE ACCESORIOS GOL (AB9), SAVEIRO 97, CADDY DIESEL 1.9 / 1.9SDI CON AIRE ACOND. (2 POLEAS LISAS)	Poleas: Ø76 X 31 L=77.4 Ø69 x 26 L=72	(028.260.299.2) VKM 01105 SIN AMORTIGUADOR
1597		POLY V AUTOTENSOR DE ACCESORIOS GOL (AB9) , SAVEIRO 97, CADDY DIESEL 1.9 /1.9SDI SIN AIRE ACOND. (1 POLEA LISA Y 1 MULTICANAL)	Poleas: Ø76 X 31 x Ø17 L=77,4 Ø75 x 26 Distancia al apoyo L=72 Polea Acanalada	VKM 01103 (028.260.299.1) SIN AMORTIGUADOR
1598		DISTRIBUCIÓN AUTOTENSOR GOL, POLO, GOLF III, PASSAT, CADDY, TRANSPORTER, SAVEIRO, SARAN MOTOR 1.9D/SDI/ TDI	Ø66.8 x26 L=37.8 mm	(028.109.243F) INA F-232486 VKM 11014
1599		DISTRIBUCIÓN AUTOTENSOR GOLF IV, BORA, CADDY, NEW SAVEIRO, POLO, NEW BEETLE MOTOR 1.9SDI / TDI 99/AGR/AGP/AQM/ASV/ALH	Ø66.8 x26 L=42.8 mm	(038109243F/G/N) INA F-232604 VKM 11130
1600		POLY V AUTOTENSOR DE ACCESORIOS DE GOL (AB9), QUANTUM, SAVEIRO 97 NAFTA 1.6 – 1.8 -2.0 C/ A.AC. (2 POLEAS LISAS)	Polea: Ø76X31xØ17 L=76 mm	(377.260.299) VKM 60008
1601		POLY V AUTOTENSOR DE ACCESORIOS GOL (AB9), SAVEIRO NAFTA 1.6 – 1.8 – 2.0 SIN AIRE ACOND. (1 POLEA LISA Y 1 MULTICANAL)	Polea: Ø76x31xØ17 L=76 mm Polea Ø75x26xØ17 L=70.9 mm	(377.145.299) VKM 60009
1602		DISTRIBUCIÓN Polea Fija Bora - Passat – New Beetle - Polo - Suran – Fox / 1.9 TDI - SDI AGR /AHF/ALH/AQM/ASV	Ø28.3 xØ8.3x 29	(58109244) INA F-227242 VKM 21004
1603		DISTRIBUCIÓN Polea Fija Bora - Golf IV - New Beetle - Passat - Sharan 1.9 TDI AJM/ANU/ATD/AXR/ARL/ASZ	Ø28.3 xØ8.3x 34	(045109244A XM216K297AA) INA F-234845 VKM 21142

Artículo Article		Modelos que reemplazan Models that they replace	Dimensiones Dimensions	Equivalencias Equivalences
1604		DISTRIBUCIÓN TENSOR DISTRIBUCION VW BORA / GOLF IV / SHARAN / SURAN 05/-> POLO MOTOR 1.9 TDI 110CV FOX 1.9SDI	Ø80 x Ø10 x 29 L=47.5mm	(038 109 244) VKM 21130 532011110 T42050
1605		DISTRIBUCIÓN Tensor Bora Golf IV 1.9 TDI 90 HP AGR-ALH / 1.9 TDI 110 HP AHF-ASV / POLO 1.9 TDI AGR - ALH - ASV	Ø28.5 x Ø8 x 29 L=47mm	532016510 T42031 INA F-231223 VKM 21131
1606		DISTRIBUCIÓN Tensor BORA 1.9 TDI 100 HP AXR / ATD 02/.. / GOLF IV 1.9 TDI 100 HP AXR / ATD 02/.. MULTIVAN 1.9 TDI AXB-BRS / PASSAT AN 1.9 TDI AXB-BRS / PASSAT y VENTO 2.0 TDI / SHARAN 1.9 TDI / TIGUAN, TOURAN y VENTO 2.0 TDI	Ø40 x Ø8,5 x 36 L=51mm	532034910 F-239652 VKM 21147 T43061
1607		DISTRIBUCIÓN AMAROK 2.0 TDI SURAM CROSS 1.6	Ø70,3 x 28 x Ø8	VKM 31008 GATES T36248 INA 532046810 F-552285
1608		DISTRIBUCIÓN FOX 1.6 10.2003-> GOL (98) 1.4 8V. 01.2011-> SURAN (11) 1.6 07.2010-> Saveiro 1.6 CFZ 04.2010-> VOYAGE 1.6 8V. NAFTA 11.2008-> GOLF (98) 1.6 06.2001-> GOL TREND 1.6 09.2008-> SURAN 1.6 10.2006-> CROSSFOX 1.6 10.2005-> SURANCROSS 1.6 04.2011->	Ø62 x 22 L=50.5 mm	531052530 F-550812 VKM 11107 T43061
1609		POLY V Fox 1.6, CrossFox 1.6 Suran 1.6 Gol Trend 1.6 Golf (98) 1.6 Voyage 1.6 8v. Nafta Suran (11) 1.6 Suran Cross 1.6	Ø76 x 26 x Ø10 L=34 mm.	532032630 INA F551814 VKM 31207 T36083
1610		POLY V Passat (3B3) 2.5 TDI; (3B2) y (3B6) 2.8 Variant (3B6) 2.5 TDI; (3B5) y (3B6) 2.8	Ø76x25xØ17	531075130 INA F550491 VKM 31039 T38059
1611		DISTRIBUCIÓN VW GOLF 1.0 C/D.H 8v y16v 98/03 Polea para tensor auxiliar	Ø76 x 24 x Ø17	VKM 04838 A
1612		DISTRIBUCIÓN Bora 1.8 / Golf (83') 1.8 / Golf (98') 1.8 Turbo / Sharan 1.8 Turbo	Ø 29 x Ø10 x 27	533003020 F-125068 VKM 21115 T-43025





Artículo Article		Modelos que reemplazan Models that they replace	Dimensiones Dimensions	Equivalencias Equivalences
1612 P		DISTRIBUCIÓN VW Bora 1.8 / Golf (83') 1.8 / Golf (98') 1.8 Turbo / Sharan 1.8 Turbo	Ø 29 x Ø10 x 27	532031010 F-552282 VKM 21220 POLEA SOLA T42019
1613		DISTRIBUCIÓN Suran (11) 1.6 / Gol (98') 1.0 MI Golf (89') 2.0 i	Ø62 x 22 L=50.5 mm	531025230 INA F-232489 VKM 11106 T43046
1614		DISTRIBUCIÓN Bora; Passat (98' y 01') Sharan y Transporter 1.9 TDI Golf IV 1.9 TDI Vento 1.9 TDI	Ø68 x 31 L=48 mm	534020320 INA F-551286 VKM 11250 T43010
1615		DISTRIBUCIÓN Golf (98') 1.6 y Golf (95'; 96' y 98') 2.0 Bora 2.0 / Vento 2.0 8v. New Beatle 2.0	Ø72 x 25 L=40 mm.	534016410 INA F-560261 (ex F-123814) VKM 11113 T38420
1616		DISTRIBUCIÓN VW AMAROK 2.0 TDI FOX / SURAN	Ø70 x 24 L=95 mm	534016410 T38427 VKM 31058
1617		DISTRIBUCIÓN AMAROK 2.0 TDI Polea guía	Ø40 x 29 x Ø8,5 L=46,5	532062310 VKM 21148 GATES T42309 F-576377
1618		DISTRIBUCIÓN VW AMAROK 2.0 TDI 122 / 163 / 180 cv Polea guía	Ø80 x 29 x Ø10	VKM 21269 GATES T42305 INA 532052710 F569697
1619		DISTRIBUCIÓN VW AMAROK / PASSAT 2.0 TDI	Ø68 x 26 x Ø9 L=46 mm	Bosch 1987947477 T43216 F577090 531082510 VKM 11269
1622		DISTRIBUCIÓN VW GOL 1.4 8v VW GOL 1.4 8v y 16v	Ø76 x 24 L=83 mm	VKM 04774 F567409 534017610



Artículo Article		Modelos que reemplazan Models that they replace	Dimensiones Dimensions	Equivalencias Equivalences
1622 P		POLY V Polea recambio VW GOL 1.4 8v GOL 1.0 8v y 16v	Ø76 x 24	Polea reparación VKM 04774 F567409
1632		POLY V Autotensor Volkswagen 17310 / 9150 / 18310 motor 5.9 y 8.3 lt. motor Cummins 6CT	Polea Ø74x39 L=50	OEM 3914086 VKM 910015 Dayco 89409 T38504 APV2970
1632 P		POLY V Polea recambio Autotensor Volkswagen 17310 / 9150 / 18310 motor 5.9 y 8.3 lt. motor Cummins 6CT	Polea Ø74x39x	Polea recambio VKM 910015 Dayco 89409
1633		POLY V Autotensor Volkswagen 17310 / 9150 motor 5.9 y 8.3 lt. motor Cummins 6BT Polea acanalada	Polea Ø72.5x36.5 L=50	VKM 91011 Dayco 89415 T38518 APV2742
1633 P		POLY V Polea RECAMBIO Volkswagen 17310 / 9150 motor 5.9 y 8.3 lt. motor Cummins 6BT Polea acanalada	Polea Ø72.5x36.5x dist. al apoyo 50	Polea recambio VKM 91011 Dayco 89415
1800		POLY V AMORTIGUADOR DEL AUTOTENSOR GOL (AB9), SAVEIRO 97, CADDY 1.9 DIESEL/ 1.9SDI CON Y SIN AIRE ACOND. (pertenece a los ítems 1596 y 1597)	Ø23 x 149 (entre centros) Desplaza 50 mm	

Artículo Article		Modelos que reemplazan Models that they replace	Dimensiones Dimensions	Equivalencias Equivalences
1544		DISTRIBUCIÓN Tensor Móvil VOLVO 340, 360, 440, 460, S40, V40	Polea Ø50x31 L=36mm	(30 855 993) INA F-123776 VKM 16101
1545		DISTRIBUCIÓN Tensor Fijo VOLVO 340, 360, 440, 460, S40, V40 1.9 TD D4192T	Polea Ø50x31 L=42.5 mm	(30 855 992) INA F-123474 VKM 26101
1556		POLY V Polea Fija de ACCESORIOS VOLVO S40 / V40 Motor 1.9 TD D 4192 T2	Ø50 x Ø8 x 26	INA F-122530.12 VKM 36016
1565		POLY V Polea VOLVO S40 / V40 Motor 1.9 TD D 4192 T2 / T3 / T4	Ø61 X 26 X Ø17	(30883834) INA 124059 VKM 36031 APV 2159
1577		POLY V VOLVO C30; V50; V70 2.4 850 2.5; C70; S70 2.0 S40; V40 1.8 2.0 S60 2.3TS 2.4T 2.5T XC70; XC90 2.5 2.5T	Ø53 x Ø8 x 27	INA F-124274 VKM 26602
1643		POLY V Polea recambio VOLVO S 40/ V 40 (1.9 TD, D4192 T3)T	Ø65 x Ø17 x 31	Polea recambio 1731713 BK3Q6A228BD

Artículo <i>Article</i>	Modelos que reemplazan <i>Models that they replace</i>	Dimensiones <i>Dimensions</i>	Equivalencias <i>Equivalences</i>
<p>1643</p>  <p style="writing-mode: vertical-rl; transform: rotate(180deg);">DISTRIBUCIÓN</p>	<p>Polea recambio KIA Sportage</p>	<p>Ø65 x Ø17 x 31</p>	<p>Polea recambio 1731713 BK3Q6A228BD</p>

Artículo <i>Article</i>	Modelos que reemplazan <i>Models that they replace</i>	Dimensiones <i>Dimensions</i>	Equivalencias <i>Equivalences</i>
<p>1643</p>  <p style="writing-mode: vertical-rl; transform: rotate(180deg);">DISTRIBUCIÓN</p>	<p>Polea recambio Hyundai Santa Fe</p>	<p>Ø65 x Ø17 x 31</p>	<p>Polea recambio 1731713 BK3Q6A228BD</p>

Artículo Article		Modelos que reemplazan Models that they replace	Dimensiones Dimensions	Equivalencias Equivalences
1415		Tensor para correa CAMION FIAT 150 TURBO y BUS	Polea Ø30x38.8 L=67 mm	(4547718)
1635 P		POLY V Eurocargo 170E22 Tector y Tector Attack 170E22	Ø85 x 32 mm.	VKMCV 52006
1636		POLY V Eurocargo 170E22 Tector y Tector Attack 170E22	Ø65 x 32 L=52 mm	VKMCV 52007
1637		POLY V Eurocargo 170E22 Tector y Tector Attack 170E22	Ø65 x 32 mm.	VKMCV 52008

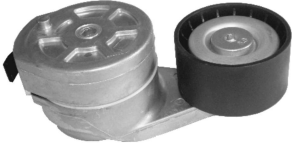
1850		POLY V SCANIA 4 SERIES	Ø 95 x Ø 10 x 32	T 36135 INA 532019810 DAYCO APV2143 F 232625 VKMCV56002
1851		POLY V SCANIA 4 SERIES	Ø 100 x Ø 10.5 x 34 Apoyo de correa Ø 95	T 36170 INA F234844 532023110 VKMCV 56001
1852		POLY V SCANIA 4 SERIES	Polea Ø 74 x 39 dist. entre centros 87 dist. al apoyo 12	T 38564 INA 531051120 DAYCO APV1057 VKMCV 56001

Artículo <i>Article</i>	Modelos que reemplazan <i>Models that they replace</i>	Dimensiones <i>Dimensions</i>	Equivalencias <i>Equivalences</i>
1700 	RULEMAN RETEN PALIER PORTA FUELLE FIAT Duna / Uno / 147, RENAULT R9, R11 (46307336)	Ø47.25xØ25.75x27.2	INA: F89628.6
1701 	RULEMAN RETEN PALIER PORTA FUELLE FIAT UNO Y DUNA HATA '90 (92601390) RENAULT R9 / R11 / Clio / R19 / Express / Megane (CON BUJE) (7700769075)	Ø47.25xØ23x27.2	INA: F120517 F110165.1
1702 	RULEMAN RETEN PALIER PORTA FUELLE FIAT Palio / Siena / Fiorino / Brava / Bravo / UNOY DUNA del '90 en adelante (CON BUJE) (46307337)	Ø47.25xØ24.5x27.2	INA: F110731
1704 	RULEMAN RETÉN PALIER PORTA FUELLE RENAULT Megane (CON BUJE)	Ø47.25xØ23.8x27.2	
1705 	RULEMAN RETÉN PALIER PORTA FUELLE RENAULT Laguna / MEGANE (770743521)	Ø47.25xØ28x27.2	INA: F120838.9 NADELLA: NE 69577

Artículo <i>Article</i>	Modelos que reemplazan <i>Models that they replace</i>	Dimensiones <i>Dimensions</i>	Equivalencias <i>Equivalences</i>
1266 	RODAMIENTO VENTILADOR R6	Polea Ø30x39 Largo 93	INA: 532036720 VKM 36017
1267 	Ford F100 / F1000 Motor mwm 4cilindros 2.8TD Chevrolet Blazer / s-10 (770743521 / 9.326.01.00005)	Ø38.1xØ18.95x80	INA: F110483.2
1268 	CHEVROLET SILVERADO MOTOR MWM SPRINT 6 CILINDROS (9.0326.01.0.0008)	Ø38.1xØ15.91x80	INA: F110483
1269 	FORD RANGER F-100, F-1000, CHEVROLET BLAZER, S-10 HATA99 / MB SPRINTER MOTOR MAXION HS 2.5D (EER2227 / 70040022)	Ø38.1xØ15.91x74.5	INA: 110607.20
1270 	Rodamiento ventilador CHEVROLET S10 2.8 TD 4x2L	Ø40 x Ø20 x 45	OEM 12642787

Artículo <i>Article</i>	Modelos que reemplazan <i>Models that they replace</i>	Dimensiones <i>Dimensions</i>	Equivalencias <i>Equivalences</i>
251 	Sembradora DEUTZ	$\varnothing 30 \times 67.8 \times \varnothing 15.9$ L=67,80mm	
252 	Sembradora DEUTZ	$\varnothing 40 \times \varnothing 16 \times 77.5$ L=77,5mm	
253 	Cosechadora GHERARDI	$\varnothing 40 \times \varnothing 17 \times 77.5$ L=77,5mm	

Artículo <i>Article</i>	Modelos que reemplazan <i>Models that they replace</i>	Dimensiones <i>Dimensions</i>	Equivalencias <i>Equivalences</i>
<p>057C</p> 	<p>FIAT CAMION 619 N1-N2 CON ROSCA EJE ORIGINAL (RODAR)</p>	<p>Ø56x70xØ25x Ø18.5 largo total 216mm rosca M18x1.5</p>	
<p>061C</p> 	<p>FIAT CAMION IVECO (sin rosca) (RODAR)</p>	<p>Ø56x70xØ25x Ø20 largo total 173.2mm</p>	
<p>062C</p> 	<p>FIAT CAMION 150N TURBO Y BUS (RODAR)</p>	<p>Ø40x50xØ20x Ø16 largo total 143mm</p>	

KIT DE DISTRIBUCION CON CORREAS 2021 - 2022



KIT DE TENSOR + CORREA: Línea Chevrolet / Fiat



> CATÁLOGO 2021 - 2022

LÍNEA QUE REEMPLAZA	KÜGELLAGER	EQUIV. SKF	KUG-GAT	FOTOGRAFÍAS
Chevrolet ASTRA - VECTRA - OMEGA 1.8 - 16 valv. / 2.0 - 16 valv. * desde 1994	30050K	VKMA 05222	1480 1475 1475 40812X24	
Chevrolet ASTRA - KADETT - OMEGA VECTRA - SUPREMA - SAFIRA 2.0 - 8v. IPANEMA - KADETT 1.8 - 8v.	30051K	VKMA 05402	1477 40802X20	
Chevrolet - Suzuki ONIX - PRISMA - CORSA 1.4 - 8 v. CORSA 1.4 - 16v. CORSA 1.6 - 8v. FUN 1.0 - 8v.	30052K	VKMA 05121	1479 40305X17	
Chevrolet - Fiat CORSA II / Meriva 1.8 - 8 v. *02-04 IDEA - PUNTO - STILO - STRADA PALIO / SIENA 1.8 8v. *04-06	30053K	VKMA 05010A	1478 40433X17HSN	
Chevrolet - Fiat - Suzuki CORSA II - MERIVA - MONTANA 1.8 - 8 v. AGILE - CELTA - PRISMA - CLASSIC 1.4 - 8 v. PALIO - SIENA - STILO - STRADA PUNTO - IDEA 1.8 8v. FUN 1.0 y 1.4 8v.	30054K	VKMA 05012A	1477 40433X17HSN	

KIT DE TENSOR + CORREA: Línea Chevrolet / Fiat



> CATÁLOGO 2021 - 2022

LÍNEA QUE REEMPLAZA	KÜGELLAGER	EQUIV. SKF	KUG-GAT	FOTOGRAFÍAS
Chevrolet ASTRA -SAFIRA 2.0 16v	30057K	VKMA 05224	1480 1432 1432 40168X24XS	
Chevrolet - Daewoo AVEO - AVEO G3 - SONIC 1.6 16v NUVIRA 1.6 16v RACER CIELO 1.5 16v ESPERO 1.5 16v / LANOS 1.6 16v	30059K	VKMA 90000A	1641 1433 76127X25,4XS	

KIT DE TENSOR + CORREA: Línea Fiat / Citroën / Renault



> CATÁLOGO 2021 - 2022

LÍNEA QUE REEMPLAZA	KÜGELLAGER	EQUIV. SKF	KUG-GAT	FOTOGRAFÍAS
Fiat DUNA / UNO / SIENA / FIORINO PALIO / STRADA / ELBA 1.7 D y 1,7 TD	30600K	VKMA 02152	1407 1408 99168X22	
Fiat FIORINO / DUNA / UNO SPAZIO / 147 1,3D	30601K	VKMA 02630	1404 1405 41133X22	
Fiat - Citroën - Renault - Peugeot - Iveco DUCATO 2.8D JTD 04 - 2.5 D DAILY 2.8 TD - 2.5 D MASTER 2.5D 99/03 BOXER 2.8 HDI JUMPER 2,8D 99/05	30602K	VKMA 02383	1421 1420 98152X30	
Fiat DUCATO 10D - 280 - 290 1.9D y TD (92/95) (Motor 149 B 1000)	30603K	VKMA 02168	1413 1414 99170X25	
Fiat DUCATO 10D 230 - 280 - 290 10D 1.9D (95/01) (Motor 149 B 1000)	30604K	VKMA 02169	1413 1414 99173X25	

KIT DE TENSOR + CORREA: Línea Fiat / Citroën / Renault









> CATÁLOGO 2021 - 2022

LÍNEA QUE REEMPLAZA	KÜGELLAGER	EQUIV. SKF	KUG-GAT	FOTOGRAFÍAS
Fiat MAREA 1.6 PALIO/SIENA/BRAVA/MULTIPLA 1.6 16v. (motor Torque) LINEA 1.9 16v	30605K	VKMA 02242	1422 1428 40825X25	
Peugeot - Iveco - Citroën - Renault DALY 2.8 TDI (99/00) BOXER 2.8 TD CITROËN Jumper 2.8 HDI 06 JUMPER 2.8 HDI 06 MASTER 2,8 DTI 99/07	30606K	VKMA 02386	1420 1420 98154X30	
Fiat PALIO/SIENA/UNO/UNO/FIORUNO FIORINO/VIVACE 1.4 - 1.6 8v SPACIO 1.4 (Motor Tipo) DUNA 1.4 MPI	30607K	VKMA 02410	1409 99138X15	
Fiat 128/128 EUROPA/128 SUPER EUROPA/UNO/DUNA/REGATTA 1.5 (83/89)	30608K	VKMA 02111	1410 41118X3/4	
Fiat PALIO/UNO/DUNA/SIENA FIORINO Motor 1,3 MPI 8V	30609K	VKMA 02412	1409 40134X17XS	

KIT DE TENSOR + CORREA: Línea Fiat / Alfa Romeo



> CATÁLOGO 2021 - 2022

LÍNEA QUE REEMPLAZA	KÜGELLAGER	EQUIV. SKF	KUG-GAT	FOTOGRAFÍAS
Fiat STRADA/PALIO/UNO/FIORINO/ SIENA 1.3 8v FIRE IDEA/PALIO/PUNTO/SIENA 1.4 8v FIRE	30610K	VKMA 02206A	1430 5627XS	 
Alfa Romeo - Geely - Fiat PALIO/SIENA/DOBLO / 500 1.3 - 1.4 16v GIULIETTA/MITO 1.4 TB EMGRAND X7 2.4 16v AT	30611K	VKMA 02204	1427 40956X22	 
Fiat - Alfa Romeo TORO 2.0 JTD 16v DIESEL BRAVO 1.6 16v (Multijet) 159 1.9 JTD	30612K	VKMA 02193	1437 1434 20199X24XS	  
Peugeot - Iveco - Fiat - Citroën - Renault FIORINO / STRADA / UNO / UNO WAY FIORINO / PALIO / SIENA 1.3 8v FIRE IDEA / PALIO / SIENA / FIORINO / PUNTO / 500 / GRAND SIENA / UNO EVO 1.4 8v FIRE	30614K	VKMA 2206-1	1435 40129X22	 

KIT DE TENSOR + CORREA: Línea Fiat



> CATÁLOGO 2021 - 2022

LÍNEA QUE REEMPLAZA	KÜGELLAGER	EQUIV. SKF	KUG-GAT	FOTOGRAFÍAS
Ford ESCORT/COURIER/ FIESTA/MONDEO 1,8D y TD 16v (95/02)	30900K	VKMA 04106	1449 1459 1462 98116X22 98085X22	
Ford ESCORT/FIESTA/MONDEO COURIER 1.8D y TD 97/03	30901K	VKMA 04107	1449 1450 1458 98116X22 98085X22	
Ford ESCORT/MONDEO 1.8 16v - 2.0 GHIA Nafla - Motor Zetec	30902K	VKMA 04212	1457 1460 1461 76131X25.4XS	
Ford SIERRA 1,6 LE MAX (84/92)	30903K	VKMA 04001	1464 41122X3/4	
Ford FIESTA/FOCUS/ECOSPORT 1.6 16v (SIGMA) KA 1.5 16v	30904K	VKMA 04226A	1441 76117X22XS	

KIT DE TENSOR + CORREA: Línea Ford / Maxion



> CATÁLOGO 2021 - 2022

LÍNEA QUE REEMPLAZA	KÜGELLAGER	EQUIV. SKF	KUG-GAT	FOTOGRAFÍAS
Maxion MOTOR MAXION 2.5 - 2.8 TDI CHEVROLET BLAZER-S10-SUN 2.5D TD FORD F100-F150 - RANGER 2.5 TDI RANGER 2.5 - 2.8 TDI MERCEDES BENZ SPRINTER 2.5 D LAND ROVER DISCOVERY - DEFENDER RANGE ROVER 2.5 TD-TDI	31150K	VKMA 07405	1465 1466 40933X30	
Maxion MOTOR MAXION 2.5 - 2.8 TDI CHEVROLET BLAZER-S10-SUN 2.5D TD FORD F100-F150 - RANGER 2.5 TDI RANGER 2.5 - 2.8 TDI MERCEDES BENZ SPRINTER 2.5 D LAND ROVER DISCOVERY - DEFENDER RANGE ROVER 2.5 TD-TDI	31151K	VKMA 7405AC	1465 1466 1621 40933X30	
Ford FOCUS 1.8 16v - 2.0 16v (zetec-E) ESCAPE 2.0 16v (zetec-E)	31152K	VKMA 04214	1446 1447 76129X25,4HSN	

KIT DE TENSOR + CORREA: Línea Citroën / Peugeot



> CATÁLOGO 2021 - 2022

LÍNEA QUE REEMPLAZA	KÜGELLAGER	EQUIV. SKF	KUG-GAT	FOTOGRAFÍAS
River - Suzuki - Peugeot - Citroën BERLINGO/BX/EVASION/XANTIA/ XSARA ZX 1.9 D/TD/TDI, C15 1.8D BOXER/405/306/406/PARTNER 1.9 TD/TDI/XSD/XSPT, 205 1.8D 208 1.8 TD VITARA 1.9 D	31200K	VKMA 03241	1493 1498 58136X1XS	
Peugeot - Citroën 306 2.0 16v 605/306 / 406 2.0 XU10J4R 95/03 XSANTIA / XSARA 2.0 16V XU10JR4 98/06	31201K	VKMA 03213	1516 1520 40934X1HSN	
Peugeot - Citroën 205 / 206 / 306 XN / PARTNER Motor 1,4i TU3JP AX / SAXO / ZX / BERLINGO Motor 1,4 TU3JP	31202K	VKMA 03110	1510 58108X17	
Peugeot - Citroën BERLINGO - ZX 1.8 / BX 1.9 XANTIA - XM - ZX 2.0 PARTNER - 405 1.8 / 405 1.9 405 - 306 - 806 - 605 2.0 XU10J2	31203K	VKMA 03201	1510 58114X17XS	
Peugeot - Citroën 205 / 206 / 306 Motor 1,6 16v AX Motor 1,4 XASO - XSARA - ZX 1.6 16v	31204K	VKMA 03111	1510 58101X17	

KIT DE TENSOR + CORREA: Línea Peugeot / Citroën



> CATÁLOGO 2021 - 2022

LÍNEA QUE REEMPLAZA	KÜGELLAGER	EQUIV. SKF	KUG-GAT	FOTOGRAFÍAS
Peugeot - Citroën XSARA / BERLINGO / C15 1.9D DW8 206 / 207 / 306 / PARTNER EXPERT 1.9D DW8	31205K	VKMA 03244A	1514 1515 40140X25,4XS	
Chevrolet - Peugeot - Citroën - Suzuki GRAND VITARA 2.0 TDI BERLINGO / C4 / C5 / XANTIA / XSARA / XSARA PICASSO 2.0 HDI PARTNER / EXPERT / 806 / 406 / 307 / 306 / 206 / 207 / 807 2.0 HDI	31206K	VKMA 03247A	1514 1515 40141X25,4XS	
Peugeot - Citroën BERLINGO / XSARA / C3 1.6 16v PARTNER / 206 / 307 1.6 16v TUSJP4	31207K	VKMA 03132	1526 1522 99134X25,4XS	
Peugeot - Citroën - Ford 207 1.4 HDI FIESTA / ECOSPORT 1.4 TDCI C3 1.4 HDI	31208K	VKMA 03140	1468 1533 20144X25,4	
Peugeot - Citroën 307 / 308 / 408 / EXPERT / PARTNER 3008 1.6 HDI C4 / C4 LOUNGE / C4 PICASSO / BERLINGO / GRAND PICASSO 1.6 HDI	31209K	VKMA 03259	1468 1533 20137X25XS	

KIT DE TENSOR + CORREA: Línea Peugeot / Citroën



> CATÁLOGO 2021 - 2022

LÍNEA QUE REEMPLAZA	KÜGELLAGER	EQUIV. SKF	KUG-GAT	FOTOGRAFÍAS
Peugeot - Citroën C4 / XSARA / XSARA PICASSO 2.0 16v 806 / 406 / 307 / 206 / 406 / 2.0 16v 406 / 407 2.2	31210K	VKMA 03235	1521 1517 70153X25,4XS	
Peugeot - Citroën - Fiat PARTNER / PARTNER II / 106 / 207 1.4i 208 1.5i C3 / PICASSO / C3 AIRCROSS 1.5i C3 / BERLINGO / BERLINGO II 1.4i QUBO 1.4	31211K	VKMA 3254A	1534 58104X17	
Peugeot - Citroën PARTNER / HOGGAR / 206 / 207 / 301 / 307 1.6 16v 208 / 301 / 308 / 408 / 2008 / CROSSWAY / PARTNER 1.6 VTI C3 / C3 AIRCROSS / C3 PICASSO / C-ELISSE C4 / C4 LOUNGE / C4 CACTUS / XSARA / XSARA PICASSO / BERLINGO 1.6 16v	31212K	VKMA 03256	1644 1518 99134X25,4XS	
Peugeot - Citroën 307 / 308 / 407 / 408 / 807 2.0 16v C4 / C5 / C5 PICASSO / GRAND PICASSO 2.0 16v	31213K	VKMA 03263	1536 1517 70153X25	

KIT DE TENSOR + CORREA: Línea Renault



> CATÁLOGO 2021 - 2022

LÍNEA QUE REEMPLAZA	KÜGELLAGER	EQUIV. SKF	KUG-GAT	FOTOGRAFÍAS
Renault MEGANE / SCENIC / LAGUNA / KANGOO Motor 1,9 DTI F9Q	31500K	VKMA 06115	1544 1552 5561XS	
Renault MEGANE / LAGUNA / SCENIC 2,0 Motor F3R 798	31501K	VKMA 06123	1544 1545 1555 58127X3/4	
Jeep - Renault CHEROKEE 2.1 TD 18 / 21 / 25 / ESPACE / MASTER / TRAFIC D/TD - ASPIRADA	31502K	VKMA 06213	1543 1561 58148X1	
Renault 19 / TRAFIC 1,9 D F8Q 740 / 606	31503K	VKMA 06124	1544 1545 1554 76153X1	
Renault CLIO / KANGOO / EXPRESS / MEGANE Motor D/TD 1,9 F8Q (11-96)	31504K	VKMA 06116	1544 1551 76151X1	

KIT DE TENSOR + CORREA: Línea Renault



> CATÁLOGO 2021 - 2022

LÍNEA QUE REEMPLAZA	KÜGELLAGER	EQUIV. SKF	KUG-GAT	FOTOGRAFÍAS
Renault CLIO / KANGOO / EXPRESS / MEGANE Motor D/TD 1,9 F8Q (11-96...)	31505K	VKMA 06126	1544 1551 1554 76151X1	
Renault CLIO II / KANGOO / MEGANE SCENIC / SANDERO STEPWAY / EXPRESS / LOGAN / SYMBOL / DUSTER 1,6 16V K4M	31506K	VKMA 06020	1563 1566 40850X27	
Renault 19 / 21 Motor 1,7 Nafta F3N 19 / CLIO 1.8 F3P	31507K	VKMA 06101	1544 1545 58125X3/4	
Volvo - Renault 19 / TRAFIC 1.9 D/TDI Motor F8Q S40 / V40 1.9TDI	31508K	VKMA 06114	1544 1545 76153X1	
Peugeot - Renault 505 2.0 XN1-A FUEGO / MASTER / 18 / 21 / TRAFIC 2,0 J6R 86/94/J5R-718	31509K	VKMA 06201	1541 58116X3/4	

KIT DE TENSOR + CORREA: Línea Renault



> CATÁLOGO 2021 - 2022

LÍNEA QUE REEMPLAZA	KÜGELLAGER	EQUIV. SKF	KUG-GAT	FOTOGRAFÍAS
Renault 18 / 21 / 25 / ESPACE / FUEGO / TRAFIC 2.2 Motor J5T/J6T/J7T	31510K	VKMA 06203	1541 58118X3/4	
Renault 19 1.4 (E6J - 700) CLIO 1.4 (E7J - 757) MEGANE 1.6 8v (K7M)	31511K	VKMA 06000A	1557 58095X17	
Renault CLIO / KANGOO / EXPRESS / MEGANE motor 1,9 D/DT F8Q	31512K	VKMA 06116	1560 1551 76151X1	
Renault CLIO / KANGOO / EXPRESS / MEGANE Motor 1,9 D/DT	31513K	VKMA 06126	1560 1551 1554 76151X1	
Renault CLIO II / CLIO III / CLIO MIO 1.2 16v (Motor D4F)	31514K	VKMA 06002A	1569 76095X23,4XS	

KIT DE TENSOR + CORREA: Línea Renault











> CATÁLOGO 2021 - 2022

LÍNEA QUE REEMPLAZA	KÜGELLAGER	EQUIV. SKF	KUG-GAT	FOTOGRAFÍAS
Renault KANGOO 1.4 (E7J-780) CLIO / KANGOO / MEGANE / LOGAN / SIMBOL / SANDERO 1.6 8v (K7M)	31515K	VKMA 06003A	1559 58096X17XS	
Renault CLIO / KANGOO / MEGANE / LOGAN / SANDERO STEPWAY / SIMBOL 1.5 DCI (Motor: K9K)	31516K	VKMA 06134	1567 76123x27XS	
Renault LAGUNA 1.8 16v (F4P) MEGANE / SCENIC / GRAND SCENIC 2.0 16v (F4R)	31517K	VKMA 06106	1576 1575 40126X27XS	
Renault MEGANE / SENIC 1.9 DTI (FQ9)	31518K	VKMA 06128	1564 1573 5561XS	
Fiat - Citroën - Renault - Peugeot - Iveco OROCH / SANDERO / DUSTER / MEGANE III / FLUENCE / CAPTURE 2.0 16v (F4R)	31521K	VKMA 06104	1576 1566 40126X27XS	

KIT DE TENSOR + CORREA: Línea Volkswagen / Seat



> CATÁLOGO 2021 - 2022

LÍNEA QUE REEMPLAZA	KÜGELLAGER	EQUIV. SKF	KUG-GAT	FOTOGRAFÍAS
Audi - Seat - Volkswagen CADDY / GOL / GOLF / POLO / VENTO PASSAT 1.9 TDI/SDI ALHAMBRA / CORDOBA / IBIZA / TOLEDO 1.9 TDI/SDI A4 / A6 1.9 TDI	31800K	VKMA 01014	1594 1598 63137X25,4XS	  
Audi - Seat - Volkswagen CADDY / GOL / POLO CLASSIC / SABEIRO / TRANSPORTER 1.9 D/TD/SD CORDOBA / IBIZA / INCA / TOLEDO 1.9 D TD/TDI AUDI 80 1.9 TDI	31801K	VKMA 01013	1598 63137X25,4XS	 
Ford - Seat - Volkswagen ESCORT / ORION 1.6 ESCORT / GALAXY / ORION 1.8 ESCORT / GALAXY / ORION 2.0 CORDOBA / IBIZA / TOLEDO 1.8 CADDY / GACEL / GOL / PARTNER / POLO / SAVEIRO 1.6 CARAT / GACEL / GOL / PASSAT / POINTER / POLO / GANTUH 1.8 CARAT / GOL / GOLF / POINTER / GANTUH / SANTANA 2.0	31802K	VKMA 01000	1452 41121X18	 
Volkswagen GOL / SAVEIRO / SENDA / GACEL Motor 1,6 DIESEL (API 1.6 D BE)	31803K	VKMA 01010	1592 45135X1	 

KIT DE TENSOR + CORREA: Línea Volkswagen / Seat / Audi



> CATÁLOGO 2021 - 2022

LÍNEA QUE REEMPLAZA	KÜGELLAGER	EQUIV. SKF	KUG-GAT	FOTOGRAFÍAS
Volkswagen GOL TREND / FOX / CROSSFOX / SURAN / SURAN CROSS / GOLF / SAVEIRO / VOYAGE 1.6 8v (nafta) VOYAGE 1.6 8 v (diesel)	31804K	VKMA 01107	1608 90135X19XS	
Volkswagen - Seat GOL 1.0 Mi 8v FOX / GOL TREND / SURAN 1.6 CORDOBA / IBIZA 1.4 IBIZA 1.0 (AER)	31805K	VKMA 01106	1613 90135X19XS	
Audi - Seat - Volkswagen GOLF 1.6 BORA / GOLF / NEW BEATLE / VENTO 2.0 8v CORDOBA / IBIZA / LEON / TOLEDO 1.6 ALHAMBRA 2.0	31806K	VKMA 01113	1615 90138X23XS	
Volkswagen A3 / A4 / 1.9 TDI CORDOBA / IBIZA / LEON 1.9 TDI BORA / PASSAT / SHARAN / VENTO TRANSPORTER 1.9 TDI	31807K	VKMA 01250	1614 1606 70120X30XS	
Volkswagen AMAROK / TIGUAN 2.0 TDI VENTO	31808K	VKMA 01148A	1602 1617 1618 1619 70160X25XS	

KIT DE TENSOR + CORREA: Línea Volkswagen / Seat / Audi



> CATÁLOGO 2021 - 2022

LÍNEA QUE REEMPLAZA	KÜGELLAGER	EQUIV. SKF	KUG-GAT	FOTOGRAFÍAS
Audi - Volkswagen AMAROK / VENTO 2.0 TDI Q3 2.0 TDI	31811K	VKMA 01269	1602 1606 1618 1619 70160X25XS	
Volkswagen POLO / PASSAT / GOLF / TRASPORTEUR 1.9 TD	31812K	VKMA 01011	1592 63137X25,4XS	

KIT DE TENSOR + CORREA: Línea Toyota



> CATÁLOGO 2021 - 2022

LÍNEA QUE REEMPLAZA	KÜGELLAGER	EQUIV. SKF	KUG-GAT	FOTOGRAFÍAS
Toyota 4 RUNNER / DYNA / HILUX 2.8 D DYNA / HI ACE / HILUX 2.4 D HI ACE / HILUX 3.0 D	32100K	VKMA 91124	1481 1482 58129X31	
Toyota HILUX 2.5 TD HILUX / HILUX SW4 3.0 TDI	32101K	VKMA 91711A	1487 58097X25XS	
Toyota HILUX 2.5 TD HILUX / HILUX SW4 3.0 TDI	32105K	VKMA 91920	1487 1802 58097X25XS	



KUGELLAGER

Córdoba - Argentina

e-mail: info@kugellager.com.ar
www.kugellager.com.ar